



LIGHT PROFILES



25
YEARS OF
EXCELLENCE

Looking back on the 25th milestone anniversary, we at Wipro Lighting would like to acknowledge all those who made the past 25 years successful. Each year has been filled with exciting challenges, driving innovation and unparalleled dedication and commitment of all the stakeholders in the Wipro family. We wish to express a big thank you to our clients, associates, vendors and our employees for making Wipro Lighting what it is today. Promising more lighting innovations for a better tomorrow.



25 years of lighting excellence

DRIVEN BY EFFICIENCY, LEADING BY PERFORMANCE

For 25 years, Wipro Lighting has been at the forefront in providing best-in-class lighting solutions, products and technologies for commercial and institutional lighting applications. Today, Wipro Lighting is the market leader for innovative design solutions in LED Lighting industry.

Since its inception, Wipro Lighting has always been associated with new product innovations and unique lighting concepts. Be it from high efficiency LED luminaires and lighting management systems for green buildings, we have always been on the forefront in providing comprehensive energy efficient solutions. Designed with international standards compliant long life LEDs and drivers, our luminaires are designed to suit the Indian power conditions.

Our LED product offerings are designed for application areas including modern

workspaces, industries, retail, healthcare, pharmaceutical firms, roads & highways, landscapes and many more. Wipro Lighting is one of the leading players in providing smart, intelligent & connected lighting solutions for indoor and outdoor applications.

We at Wipro Lighting have a single minded focus on enhancing competitive advantage and thereby, increasing customer profitability at all times. We stand by our commitment to implement green lighting solutions to create possibilities for a brighter future and a cleaner planet.

our milestones to success

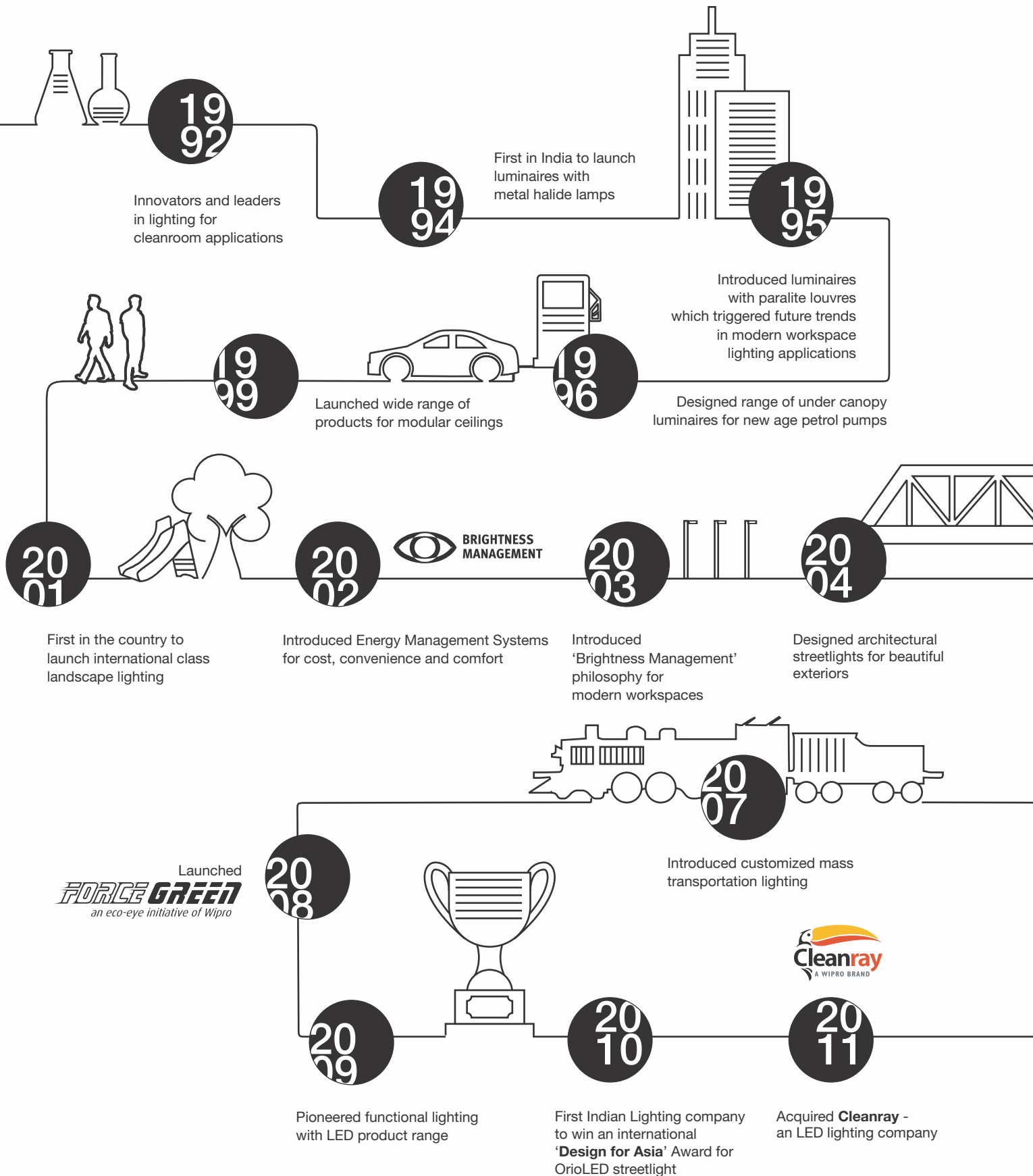



Received International Diamond Prize for Excellence in Quality 2017.



Won the **Frost & Sullivan - 2017** India LED Lighting Visionary Innovation Leadership Award

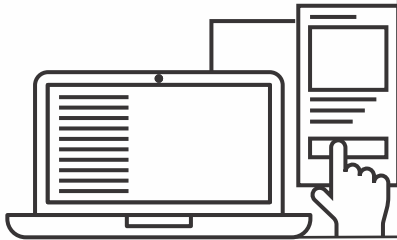

Introduced smart & connected lighting solutions for indoor and outdoor lighting applications

2017



reddot design award winner 2017

Acclaimed with the International seal of quality - Red Dot Design Award for for **VergeLED**.



Receives recognition with the acclaimed India Design Mark for **VergeLED**



VergeLED ranked in the Global SSL Showcase Top 100

2016



Receives recognition with the acclaimed India Design Mark for **PieLED**

2015



Receives recognition with the acclaimed India Design Mark for **AsimlineLED** and **TuboLED**

2014



Wins prestigious European Design award: Label Observateur Design for **Vola Streetlight**



Receives recognition with the acclaimed India Design Mark for **Vola Streetlight**



Recognised as one of the top most promising brands of Asia

2006

First lighting company in India to be associated with green movement



Collaborated with international designers



2013



Receives Green Company of the year award

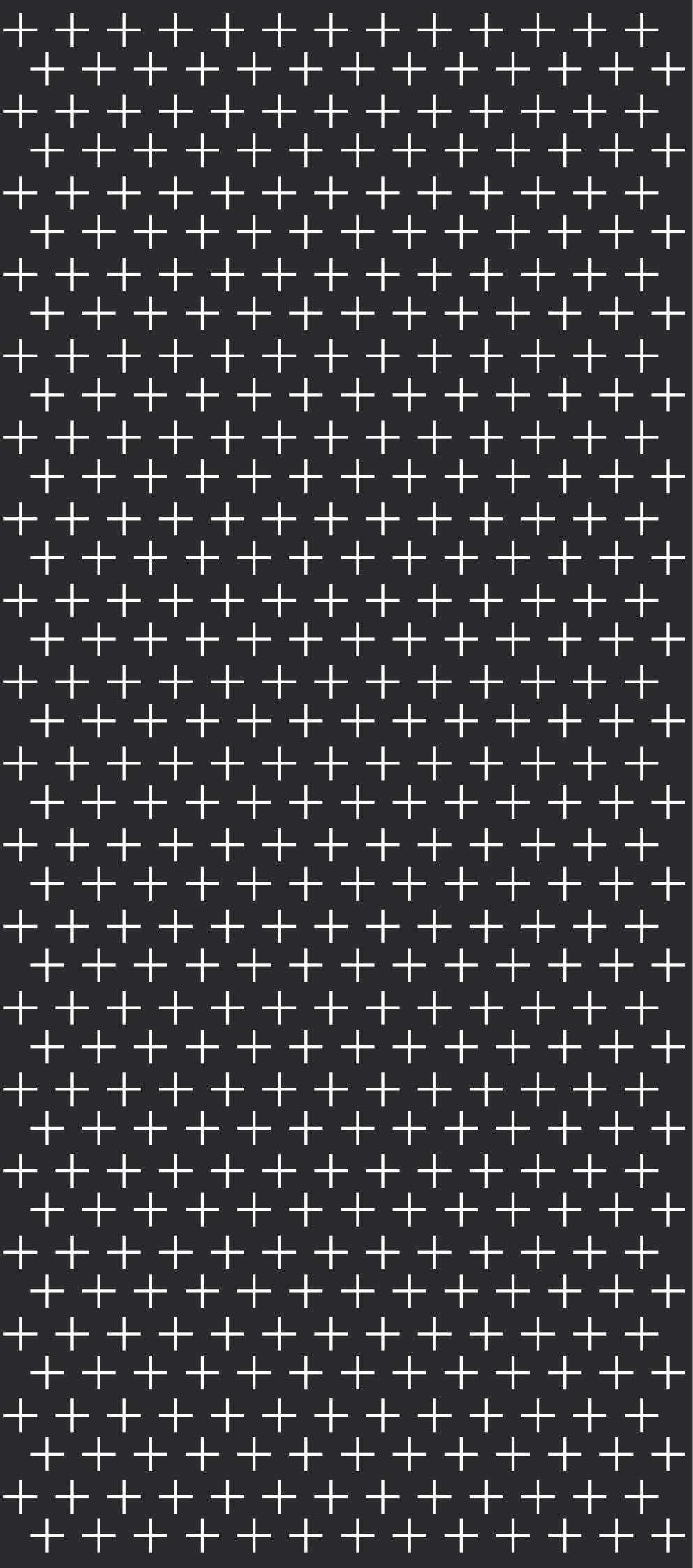

TECHNOLOGY ORIENTED

The lighting solutions at Wipro are developed with latest technology and designed to meet future needs. Today, LEDs are a lot more than mere energy-saving devices. Their efficiency and easy adaptability to dynamic shapes and forms have opened new avenues for us to explore and innovate with the latest technology.



DESIGN DRIVEN

At Wipro Lighting, we innovate designs which inspire. We explore various facets of it to illuminate ideas and enrich human experiences. The product innovation team is constantly engaged in creating new products and improving on the existing products to cater to evolving customer needs.

wipro lighting advantage



CUSTOMER CENTRIC

Wipro Lighting has an extensive network of 19 branches across the country, with over 400 dedicated stockists that help to deliver seamless services to our esteemed customers. We provide application specific solutions through customised products to suit customer needs perfectly.



MANUFACTURING EXCELLENCE

Having our own manufacturing units enables us to experiment and innovate with technology. LEDs have redefined the rules of luminaire design and have given us the opportunity to present light in new and exciting forms.



LEADERS IN LIGHTING FOR GREEN BUILDINGS

At Wipro Lighting, we focus on effectively integrating luminaires with the right optics. New generation green lighting sources, energy-efficient control gear, smart and connected lighting management system to develop vibrant, energy-efficient interiors and exteriors.



EXPERTS IN LIGHTING SOLUTIONS

We have a team of highly qualified, well-experienced lighting design professionals and application experts to understand and deliver optimum lighting solutions as per client requirements.



AWARDS & RECOGNITION

In 2017, We have received the coveted and internationally acclaimed **Red Dot Design Award, Indian Design Mark** and **Global SSL Top 100** rank for **VergeLED**. The company has also been felicitated with the **Frost & Sullivan - 2017 India LED Lighting Visionary Innovation Leadership Award**. In 2010, we were conferred the **International Design for Asia Award**. We were the first Indian Lighting company to win the highly recognized design award. We have continuously been appreciated and recognized by the acclaimed **India Design Mark** and have won the prestigious European Design Award: **Observateur du Design** in 2014.

smart & connected lighting

With over a decade of experience in standalone & connected lighting control system installations, Wipro Lighting is at the forefront in providing smart, intelligent & connected lighting solutions for smart indoor and outdoor applications.

We offer a range of energy efficient lighting solutions, control systems and components for Smart Lighting applications in indoor and outdoor facilities. With the emergence of big data, the internet of things and connected digital lighting, it is going to bring much more intelligent functionality into our lighting systems. Hence, this trend will play an important role in making our work environment more livable, enjoyable, economically sustainable and safe.



ENHANCED USER EXPERIENCE

Personalised Lighting for enhanced comfort with Individual Luminaire Level controls for intensity and colour.



WORK SPACE OPTIMIZATION

Effective Space Utilization based on occupancy data and energy usage data.

Energy mapping, time schedule based control of lighting, alerts and alarms for higher security are the key benefits.



LOWER TOTAL COSTS

Optimum Energy Usage and Cost Savings with daylight harvesting.

In outdoor, complete control with dimming, proactive fault correction, energy theft detection and analysing road traffic patterns is possible.

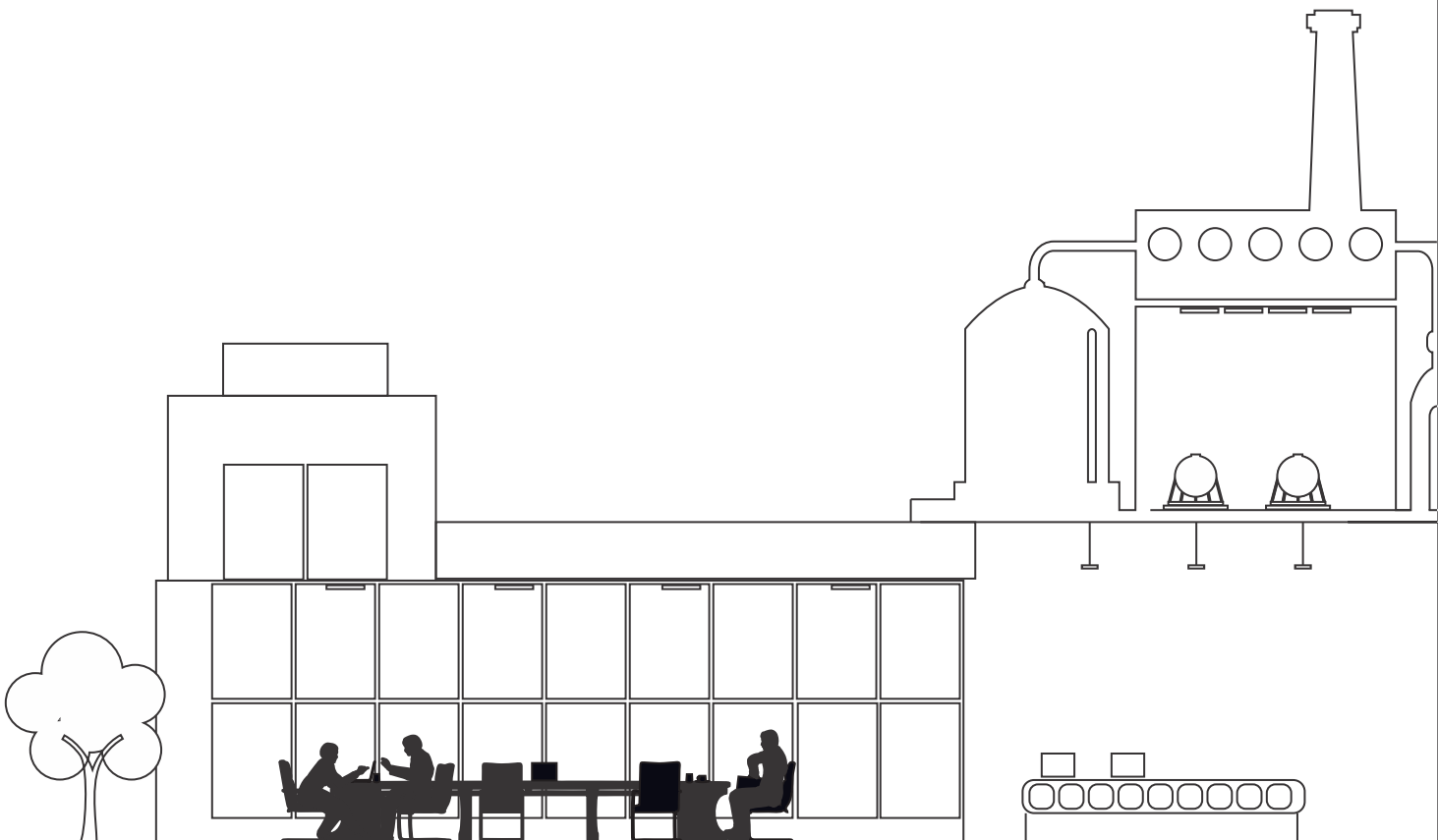



ENABLE BUSINESS ANALYTICS

Real-time & historic data, power usage patterns can be mapped and energy can be allocated based on actual requirement.



SYSTEM INTEGRATION WITH PERFORMANCE TRACKING

Smart & Connected lighting systems can be seamlessly integrated with building management systems and have a customized GUI for ease in operation and control using touch panels.



GAIN INSIGHTS

Connected to a centralized IT network, smart and connected lighting systems can be controlled remotely from smart phones, tablet apps or through web based software on desktop.

The smart & connected lighting solution architecture is highly scalable.





the
advantage



EFFICIENCY

LEDs produce more light per watt, making them about 80% more efficient than conventional light sources. Considering the high efficiency of LEDs, these are used in various applications for savings in operational costs.

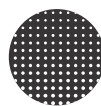

EXCELLENT COLOUR RENDERING

Colour Rendering Index is a measure of a light source's ability to show object colors "realistically" or "naturally" compared to a familiar reference source, either incandescent light or daylight. Technological advancement ensures excellent colour rendering properties of LEDs.



GREEN BY DESIGN NO MERCURY CONTENT

Conventional light sources like fluorescent lights and discharge lamps, contain a small amount of mercury. This metal and vapor is extremely hazardous to both humans and the environment. If it is ingested or inhaled it can cause serious complications and as such must be disposed safely. LEDs are completely safe and do not contain mercury.

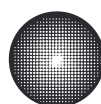

DIMMING OPTIONS

LEDs allow us to create variable dimming options which not only help to beautify spaces but also transform the surroundings completely. Lighting solutions that combine world-class LED luminaires with analog and digital controls to provide the right lighting effect wherever needed.



SHOCK RESISTANCE

LEDs being solid state devices, have higher ability to absorb shock, unlike conventional light sources which are comparatively fragile.



COMPACT IN SIZE

Due to their compact size, LEDs enable design of compact & aesthetic luminaires with proper optical control.



NO UV/IR RADIATION

Ultraviolet (UV) lighting can pose a risk to your eyes and skin, while infrared (IR) radiation creates heat. LEDs have proved to be safe to the user for general illumination.



INSTANT ILLUMINATION

LEDs unlike quite a few conventional light sources light up instantly and take only a few microseconds to achieve full brightness.



LONG SERVICE LIFE, LOW MAINTENANCE

LED light sources last longer with average service life of 50,000 hrs. This avoids hassle of frequent maintenance in terms of replacement, ensuring savings in the long term.



OPTICS

Point source form of LEDs ensures proper control of light distribution with the help of secondary optics like lenses and diffuser.

how to choose a good led luminaire

KEY PARAMETERS' CHECK LIST

Country of origin
and make

Quality of LEDs (Binning)

Lumen output

Colour temperature consistency

Compliant to LM80 standard

System lumens of LED luminaire

Compatibility with electrical environment

Multistage isolated driver

Useful system life

Protection against voltage surges

Compliance with
safety and performance standards

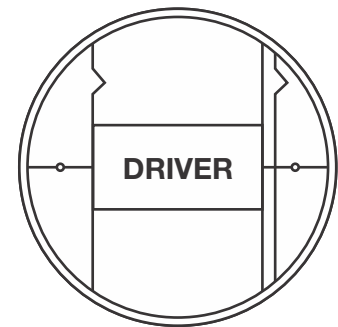
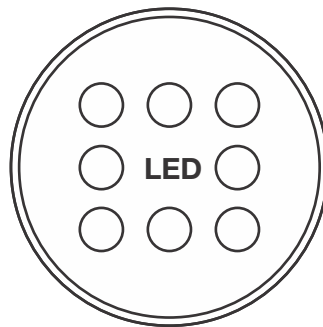

WIPRO LIGHTING OFFERINGS

Best in class LED technology from Japan

High lumen output of minimum 130
lm/watt

LM80 compliant LEDs

Strict adherence to lumen output and
colour temperature

Conforms to relevant international
standards

Constant Current Constant Voltage
(CCCV) driver

2/3 stage isolated drivers

Good design and quality components for
a long service life

Designed and manufactured in India
specially for Indian
power conditions



Designed for varying ambient temperatures
Effective heat dissipation mechanism
Maintaining junction temperature within specified limits

Uniform and glare free lighting
Good volumetric lighting
Optical efficiency

Innovative design
Latest technology
Form and function
Trusted brand

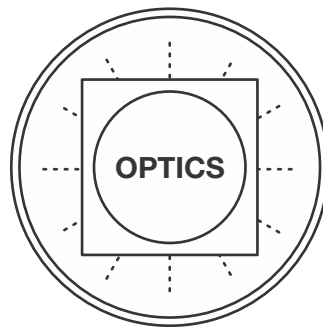

HET (High Efficiency Translucence) or LGP (Light Guide Panel) technology in most of the indoor luminaires

Uniform and glare free lighting experience with reduced LPD in indoor luminaires

Volumetric distribution for good lighting and safety

MCPCBs for high wattage LED luminaires for better heat dissipation

In all products, junction temperature is maintained well below the maximum specified limit

Luminaires can operate in varied ambient conditions

Innovative designs aligned with latest technology

Over 20 years of experience and expertise in lighting design

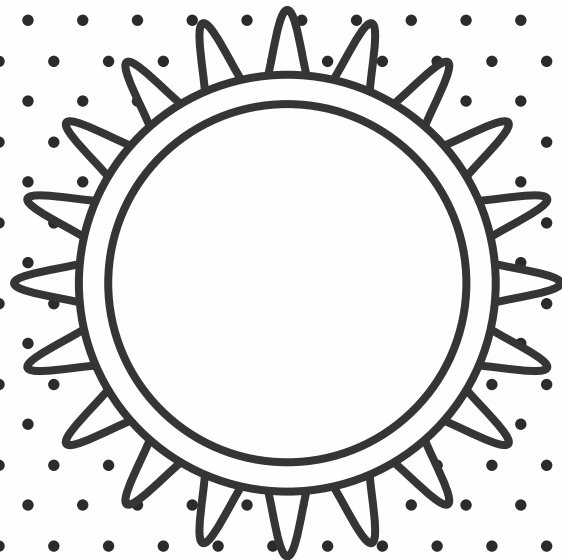



wipro lighting led solutions

TECHNOLOGY

Best-in-Class LED technology from Japan

IN-HOUSE DESIGN & MANUFACTURING

Conforms to relevant International Standards

INNOVATION & DESIGN

Engagement to create new products and improve on the existing products to cater to evolving customer needs

ENERGY EFFICIENCY

Uniform and glare-free lighting with reduced light power density

LONG SERVICE LIFE

Good design architecture & components for reliable, maintenance free operations

WIDE AREAS OF APPLICATION

Versatile applications covering functional touch-points in commercial and institutional lighting

WIPRO LIGHTING ADVANTAGE



LIGHT SOURCE

Best-in-class Japanese LED technology

High efficiency, LM 80 compliant LEDs

Best quality LEDs through proper binning for consistent colour, lumen output and forward voltage

Options in colour temperature



OPTICS

Uniform and glare free lighting

HET (High Efficiency Translucence) technology ensures high optical efficiency



DRIVERS

Constant Current Constant Voltage (CCCV), multistage and isolated design architecture

Specially designed for Indian power conditions

Best-in-class design & manufacturing

Complies to SELV design standards ensuring safety



THERMAL MANAGEMENT

Special design for effective thermal management ensures long service life and consistent performance of LEDs

Use of MCPCBs for high wattage LED luminaires

Specially designed heat dissipation mechanism

leadership in lighting for green buildings

experience

Proven track record with lighting solutions for more than 55% of the Green Buildings in the country

expertise

Dedicated team of lighting design and energy optimization experts





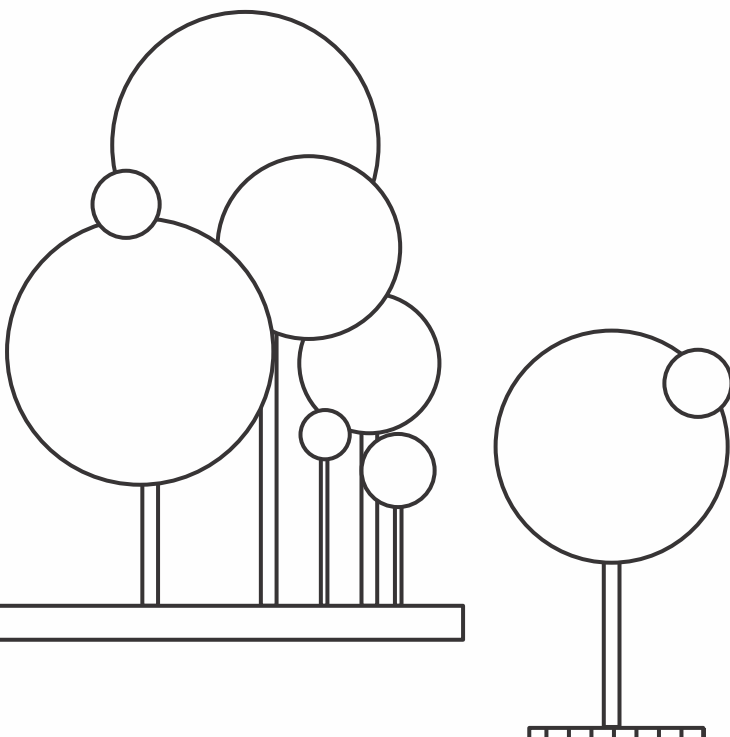

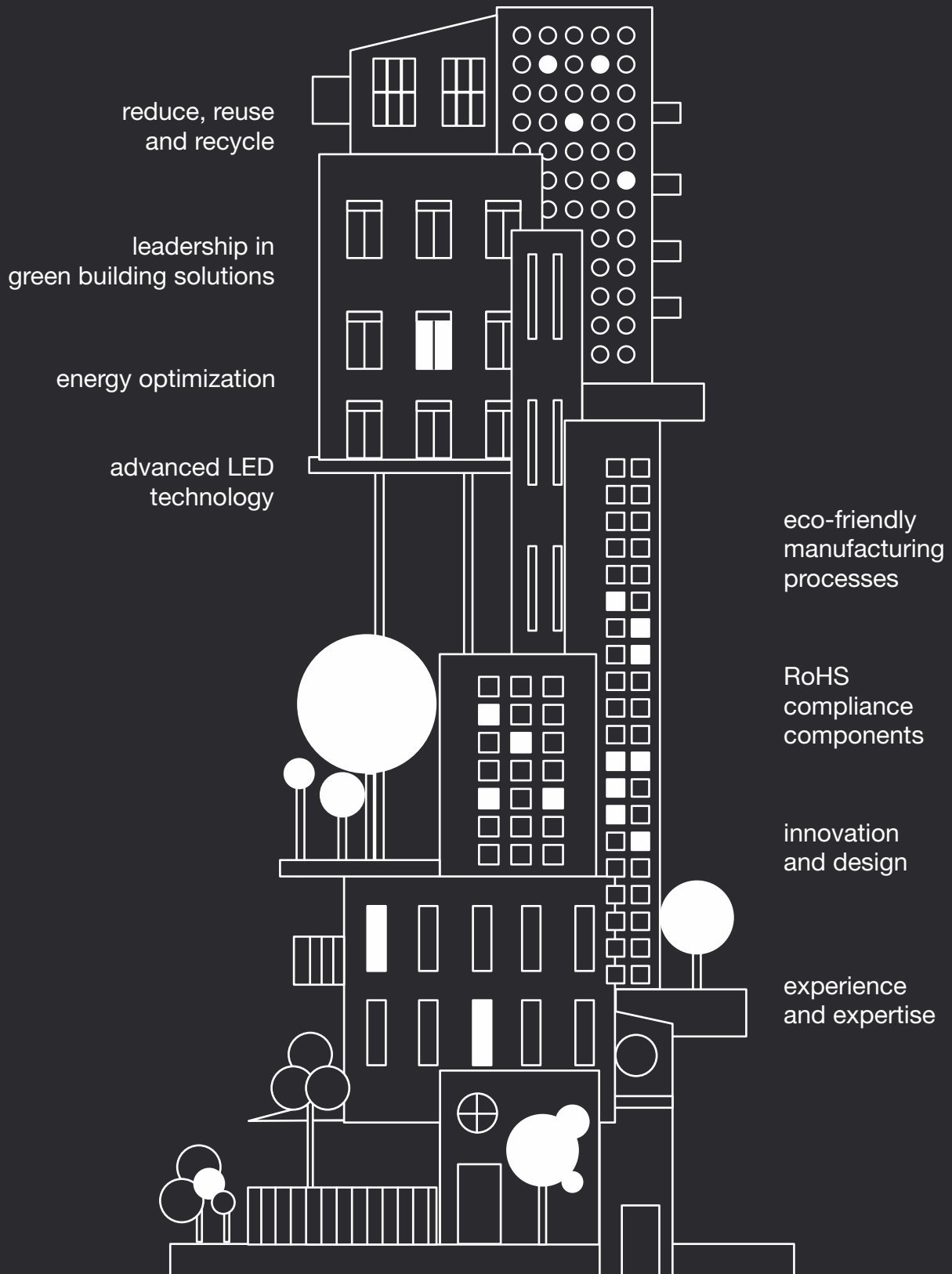

















energy optimization

High performance, energy efficient luminaires combined with lighting controls contribute to high energy savings





indoor & outdoor led luminaires

| | | | | | |
|--|---|---|---|--|---|
| MODERN WORKSPACES 01-34 | | 01  OpusLED | 03  VergeLED | 07  ImmaculateLED Trimless | 08  ImmaculateLED |
| | | 09  ImmaculateLED DD | 10  ImmaculateLED Platinum | 11  ElateLED | 12  WaveLED |
| 15  AxeonLED (Recess & Trimless) | 17  LineosLED Recess | 18  AuraPlus | 19  TZLED | 22-23  AxeonLED Dropdown & Suspended | 25  Pie LED |
| 27  Asimline LED | 29  LineosLED Suspended | 30  Axeon Surface | 31  LH 13 (Pendant luminaire) | 33  OrbitLED | 34  ComfortLED |
| COMMERCIAL INTERIORS 35-54 | | 38  Helix LED | 40  HeliosLED | 41  IrisLED |  |
| | | 42  IrisLED SQ | 43  IrisLED Gold RF | 44  IrisLED Gold DD | 45  IrisLED Gold FD |
| 49  Halo Surface (6-18W) | 50  Halo Surface (26W) | 51  LED Gimball | 52  LED Tracklight | 53  LED Gimball | 54  LED Swivel Projector |
| LIGHTING CONTROLS 55-64 | | 57  eSavvy CRPS 10 | 58  eSavvy CRPS 13 |  | |
| | | 59  eSavvy CRAD | 60  Esense COM 20/CDA 21 | 61  Esense COM 23/CDA 24 | 63  Scene Select System |

| | | | | | |
|--|---------------------------|--------------------------------|------------------------------------|------------------------|---------------------------|
| INDUSTRIES & CLEANROOM 65-84 | | 67 RadialLED Prime | 69 Radial LED | 70 LED Highbay | 71 XpressbayLED |
| 72 WellglassLED (35W) | 73 WellglassLED (70W) | 74 StormLED | 75 CapsuleLED | | |
| 76 XlineLED Pro | 77 XlineLED (LE10) | 78 XlineLED (LE 11) | 81 VisionLED Prime | 83 VisionLED | |
| STREET LIGHT & FLOOD LIGHT 85-96 | | 87 SkylineLED (low wattage) | 88-90 SkylineLED (high wattage) | 92-94 Alpha LED | 95-96 RevoLED |
| LANDSCAPES 97-104 | | 99 UrbanoLED Pathway (60W) | 100 UrbanoLED Pathway (35W) | 102 Post TopLED | |
| | 103 FantasyLED Bollard | 104 GardeniaLED | | | |
| CLEANRAY RANGE 105-124 | | 107 ElateLED | 110 ImmaculateLED Slim | 111 IrisLED Slim RO | 112 IrisLED Slim RO SM |
| 113 IrisLED Slim SQ | 114 IrisLED Slim SQ SM | 115 TrimLED Neo | 116 TrimLED | 117 ProLED | 118 ProLED Compact |
| 119 ProLED T5 | 120 WioLED | 121 SkylineLED (20W) | 122 AlphaLED Floodlight | 123 MoonLED RO/SQ | 124 FormzLED |

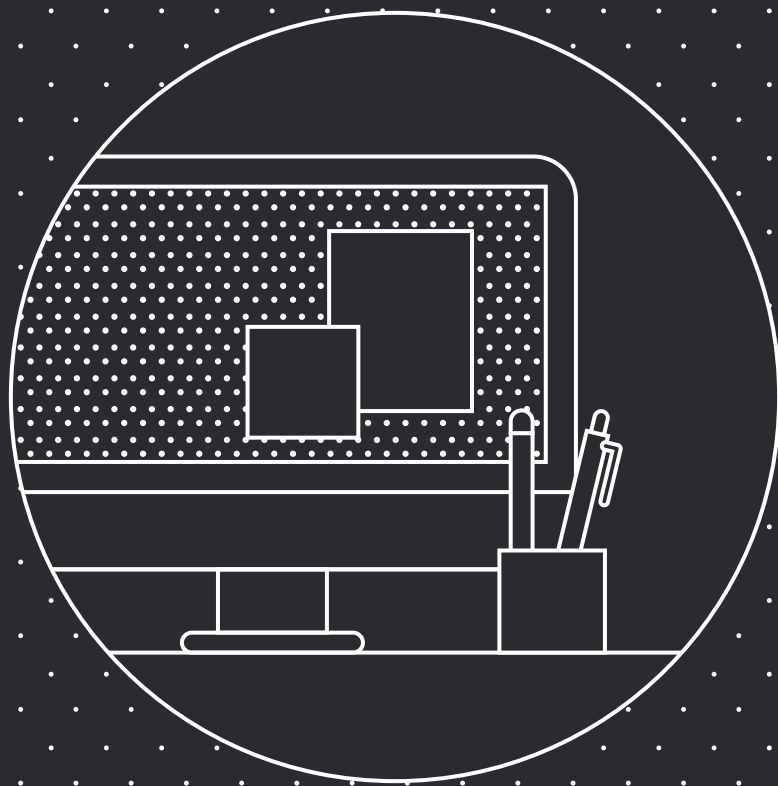



modern workspaces

OpusLED | LM 38

High efficiency recess mounted LED luminaire

APPLICATIONS



FEATURES & BENEFITS

Uniform illumination

Spherical diffuser in the center gives floating light effect.

Energy efficient

Compatible with daylight and occupancy sensor to use power effectively and reduce energy consumption.

Options in colour and light

Direct, indirect, direct-indirect light variant to suit different customer needs. Product available in warm white and cool white colour temperatures.



SPECIFICATIONS

- Recess mounted direct-indirect, LED luminaire with uniform light distribution
- White color powder coated deep drawn housing
- Unique floating spherical High Efficiency Translucent (HET)
- PMMA diffuser for direct light
- Introduces a circular geometry into the ceiling plane for visual interest
- Surrounding circular light chamber, containing PMMA diffuser for indirect light
- High efficiency LEDs
- Constant Current Constant Voltage external driver with efficiency of minimum 85 %

INSTALLATION

- Designed for installation with four nos. of Steel hook-up wire
- Suitable for Grid/Armstrong modular ceilings
- For Gypsum /POP applications additional frame (Part No: 9180P01089) needs to be ordered separately

DIMENSION DRAWINGS

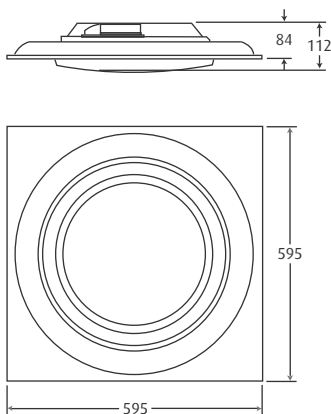

All dimensions are in mm. Tolerance ± 2 mm

LIGHT DISTRIBUTION

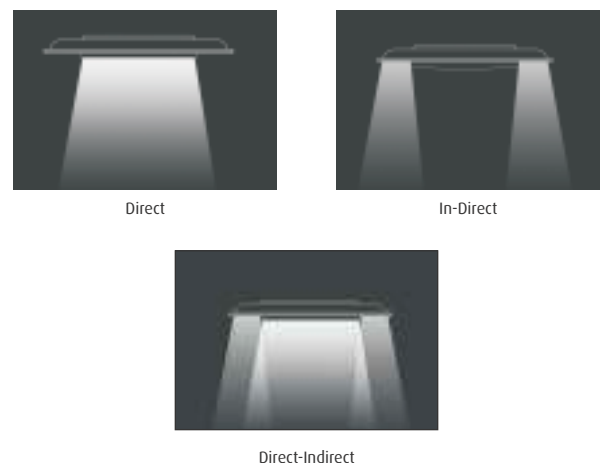

ELECTRICAL & PACKING DATA

INGRESS PROTECTION **IP20**

| Cat. No.* | Luminaire Lumen OP (Lm) | Luminaire Wattage (W) | Rated Voltage (V) | Mains Current (A) | Approx Weight (KG) | Case Lot (in nos) |
|--------------------|-------------------------|-----------------------|-------------------|-------------------|--------------------|-------------------|
| LM38-461-XXX-57-XX | 3340 | 34 | 240 | 0.15 | 3.8 | 02 |

*57 represents 5700K. Replace 57 with 40 for 4000K

LED is an ever improving and evolving technology. Wipro is committed to bring you the best in LED technology. Data given is representative and can change.



reddot award 2017
winner

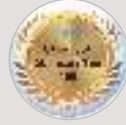

VergeLED | LM 29

High efficiency recess mounted LED luminaire

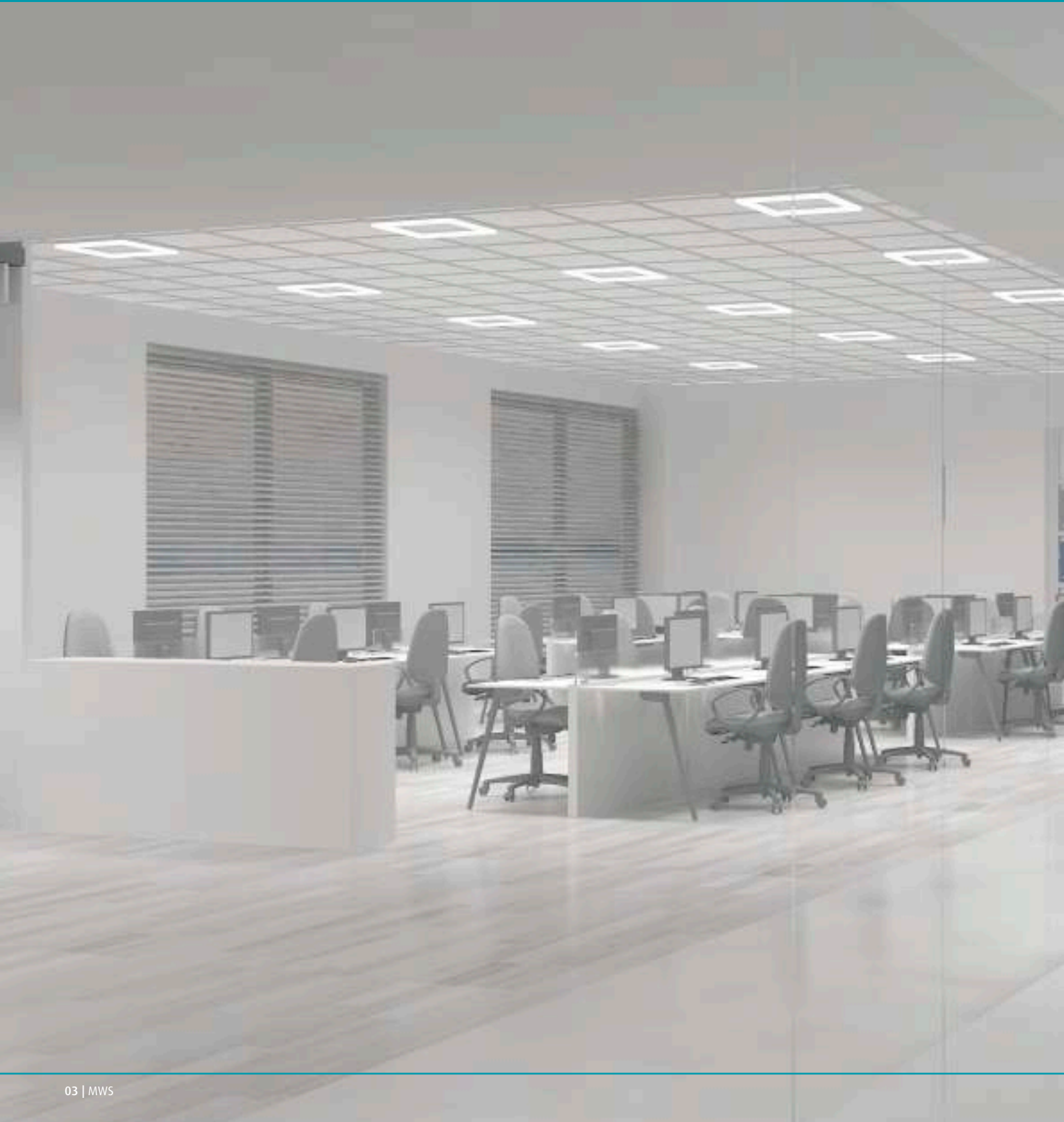



VergeLED | LM 29

INNOVATIVE DESIGN

Sleek profile of the luminaire integrates with the texture of the ceiling giving a distinct appearance.

RELIABLE AND QUALITY PERFORMANCE

Extruded aluminium housing ensures excellent thermal management resulting in reliable performance along with clean and distinct look.

HIGH ENERGY EFFICIENCY

Back lit luminaire with high efficiency LEDs save upto 60% energy, reducing the operating cost significantly.

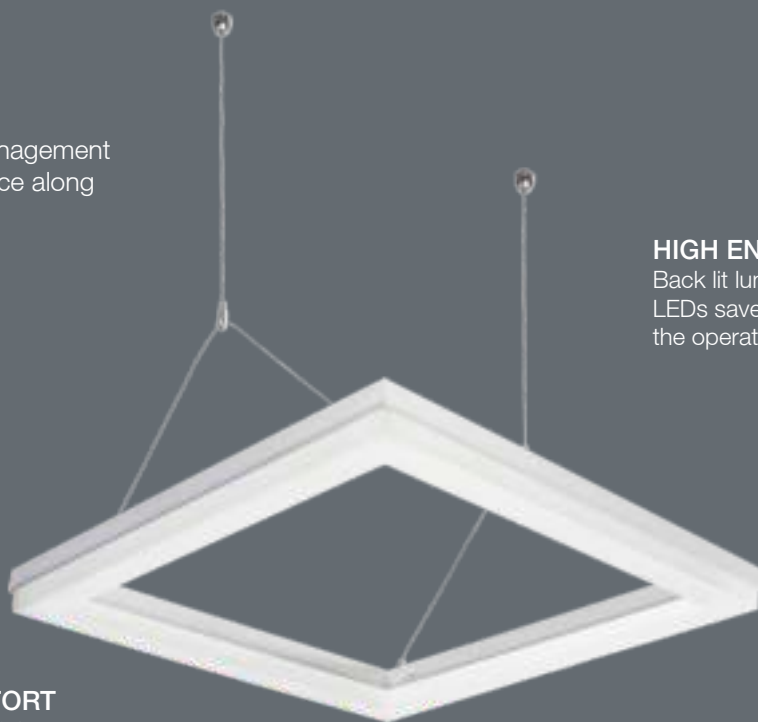

EXCELLENT VISUAL COMFORT

Unique architectural design of the LEDs on the outer periphery, provides volumetric light distribution and visually balanced light.

LONG SERVICE LIFE

Easily accessible best-in-class independent LED driver ensures maintenance free, longer service life.



SPECIFICATIONS

- High efficiency LED luminaire with backlit direct-indirect light
- Extruded, sturdy, rust-free, light-weight aluminium powder coated housing ensures best-in-class heat dissipation
- Central visible part of the fixture is ceiling tile or ceiling material like POP or Gypsum
- Thoughtfully designed LED configuration around the periphery resulting in wider, volumetric light distribution
- High efficiency LEDs with best possible chromaticity, colour consistency and uniformity by best binning process resulting up to 60% energy saving
- Insect proof LED compartment
- Optically researched, seamless HET PC diffuser with 10% uplight, 90% downlight for balanced illumination on wall, ceiling and tabletop
- Independent driver box for easy accessibility and maintenance with smart connector & pre-wired accessories
- Driver box designed for better thermal management ensuring longer service life
- Conforms to IS 10322 part 5/Sec 1: 2012

APPLICATIONS



INSTALLATION

- Designed for installation with four nos. of steel hook-up wire
- Suitable for Grid/Armstrong modular ceiling system
- Separate gear box with male/female connector provided
- Suspension is part of suspended product as per below product code
- LM29-451-XXX-57RCC - RCC ceiling pendent mounted product
- LM29-451-XXX-57GRD - Modular grid 24/15mm prelude pendent mounted product
- For Gypsum/POP applications additional frame, (Part No: 9180P01025) needs to be ordered separately

DIMENSION DRAWINGS

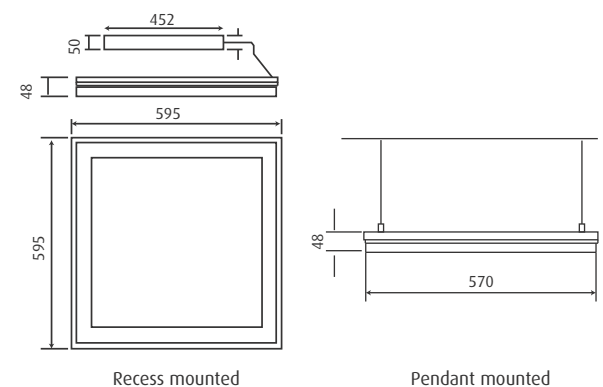

Please get in touch with Wipro Team on POP installation

All dimensions are in mm. Tolerance ± 2 mm

ELECTRICAL & PACKING DATA

INGRESS PROTECTION **IP20**

| Cat. No.* | Luminaire Lumen OP (Lm) | Nominal System Wattage (W) | Rated Voltage (V) | Mains Current (A) | Approx Weight (Kg) | Case Lot (in nos) |
|--------------------|-------------------------|----------------------------|-------------------|-------------------|--------------------|-------------------|
| LM29-451-XXX-57-XX | 3065 | 33 | 240 | 0.13 | 3.0 | 02 |
| LM29-451-XXX-57RCC | 3065 | 33 | 240 | 0.13 | 2.8 | 02 |
| LM29-451-XXX-57GRD | 3065 | 33 | 240 | 0.13 | 2.8 | 02 |

*57 represents 5700K. Replace 57 with 40 for 4000K

LED is an ever improving and evolving technology. Wipro is committed to bring you the best in LED technology. Data given is representative and can change.

ImmaculateLED Trimless | CRCO 10

Recess mounted LED luminaire with minimalist trim and full diffuser suitable for recessed grid/POP



APPLICATIONS



SPECIFICATIONS

- Thoughtfully designed with sleek and seamless aesthetics
- White powder coated housing and front cover in CRCA Sheet
- High Efficiency Translucence (HET) diffuser for better light Transmission & pure effect to avoid dark patches and create perfect diffusion of light
- High efficacy LEDs
- Uniform and optimum light output
- Ideal for green lighting solution
- Conforms to IS 10322 part 5/Sec 1 1987 comply

INSTALLATION

- Seamless integration with Grid/Armstrong modular ceiling system
- Easy installation and long service life

ACCESSORIES

- For POP/Gypsum applications additional frame Cat. No. 9180P01025 needs to be ordered separately



DIMENSION DRAWINGS

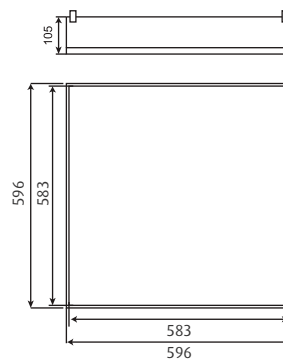

All dimensions are in mm. Tolerance ± 2 mm

ELECTRICAL & PACKING DATA

INGRESS PROTECTION **IP20**

| Cat. No.* | Luminaire Lumen OP (Lm) | Luminaire Wattage (W) | Rated Voltage (V) | Mains Current (A) | Approx Weight (KG) | Case Lot (in nos) |
|--------------------|-------------------------|-----------------------|-------------------|-------------------|--------------------|-------------------|
| CRCO10R038HP57SLAB | 3000 | 31 | 240 | 0.14 | 3.6 | 02 |

*57 represents 5700K. Replace 57 with 40 for 4000K

LED is an ever improving and evolving technology. Wipro is committed to bring you the best in LED technology. Data given is representative and can change.



ImmaculateLED | CRCO 10

Recess/surface mounted LED luminaire with full diffuser

APPLICATIONS



SPECIFICATIONS

- CRCA white powder coated housing with ABS plastic top cover for better aesthetic finish
- Highly efficient PMMA diffusers for better light transmission and pure effect
- High luminous flux LEDs for better light output
- Electronic driver duly wired up to the terminal block
- Designed and manufactured to comply with IS 10322 part 5/Sec 1 2012

INSTALLATION

- Suitable for Grid/Armstrong/POP modular ceiling system

ACCESSORIES

- For Gypsum/POP applications, CRCA powder coated frame Cat. No. 9180P01089 to be ordered separately
- For POP/Gypsum ceiling cutout dimensions are 608 mm x 608 mm

DIMENSION DRAWINGS

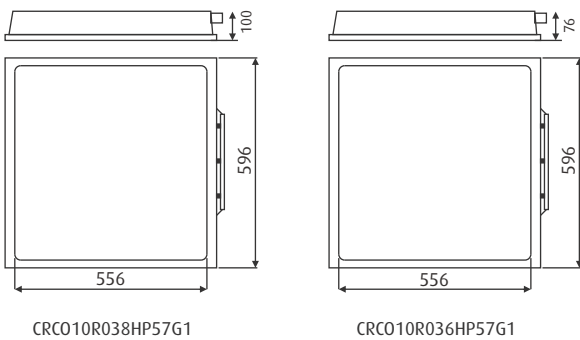

All dimensions are in mm Tolerance: ± 2mm

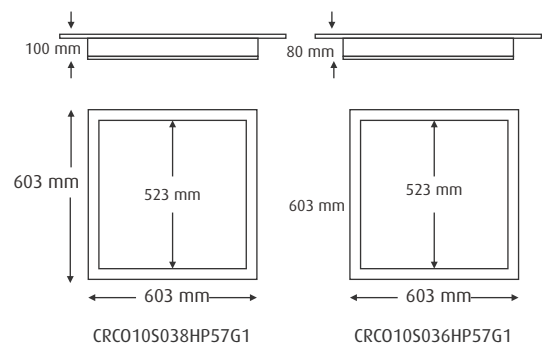

All dimensions are in mm Tolerance: ± 2mm

ELECTRICAL & PACKING DATA

INGRESS PROTECTION **IP20**

| Cat. No.* | Luminaire Lumen OP (Lm) | Nominal System Wattage (W) | Rated Voltage (V) | Mains Current (A) | Approx Weight (kg) | Case Lot (in nos) |
|------------------|-------------------------|----------------------------|-------------------|-------------------|--------------------|-------------------|
| CRCO10R038HP57G1 | 3000 | 31 | 240 | 0.14 | 3.9 | 02 |
| CRCO10S038HP57G1 | 3000 | 31 | 240 | 0.14 | 4.2 | 02 |
| CRCO10R036HP57G1 | 3300 | 33 | 240 | 0.15 | 3.9 | 02 |
| CRCO10S036HP57G1 | 3300 | 33 | 240 | 0.15 | 4.2 | 02 |

*'R' represents recess and 'S' represents surface mounting

*Other colour temperatures available on request.

LED is an ever improving and evolving technology. Wipro is committed to bring you the best in LED technology. Data given is representative and can change.

ImmaculateLED DD | LM 24

Recess mounted LED luminaire with dropdown diffuser



APPLICATIONS



SPECIFICATIONS

- White powder coated housing and front cover in plastic
- High Efficiency Translucence (HET) diffuser
- High efficacy LEDs
- IS 10322 part 5/Sec 1 1987 comply

INSTALLATION

- Suitable for Grid/Armstrong/POP modular ceiling system

ACCESSORIES

- For Gypsum/POP applications, CRCA powder coated frame Cat. No. 9180P01089 order separately
- For POP/Gypsum ceiling cutout dimensions are 608 mm x 608 mm

DIMENSION DRAWINGS

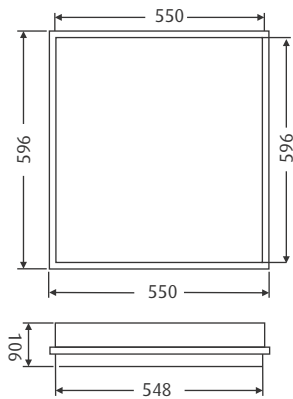

All dimensions are in mm. Tolerance ± 2 mm

ELECTRICAL & PACKING DATA

INGRESS PROTECTION **IP20**

| Cat. No.* | Luminaire Lumen OP (Lm) | Nominal System Wattage (W) | Rated Voltage (V) | Mains Current (A) | Approx Weight (Kg) | Case Lot (in nos) |
|--------------------|-------------------------|----------------------------|-------------------|-------------------|--------------------|-------------------|
| LM24-391-XXX-57-DD | 2825 | 31 | 240 | 0.14 | 3.8 | 02 |
| LM24-421-XXX-57-DD | 2973 | 33 | 240 | 0.15 | 3.8 | 02 |

LED is an ever improving and evolving technology. Wipro is committed to bring you the best in LED technology. Data given is representative and can change.



ImmaculateLED Platinum | LM 25

Recess mounted slim LED luminaire



APPLICATIONS



SPECIFICATIONS

- Extruded aluminium white powder coated housing
- Edge lit optics from reflector+light guide plate+diffuser configuration
- Low wattage high efficient LEDs
- Electronic LED driver pre-wired upto terminal block
- Excellent heat dissipation through direct contact
- Designed and manufactured to comply with IS 10322 part 5/Sec 1 2012

INSTALLATION

- Suitable for Grid/Armstrong/POP modular ceiling system

Please get in touch with Wipro Team on POP installation

DIMENSION DRAWINGS

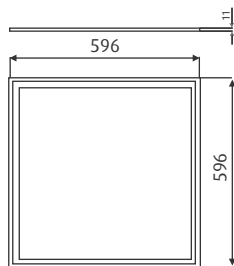

Cutout: 570mm x 570mm

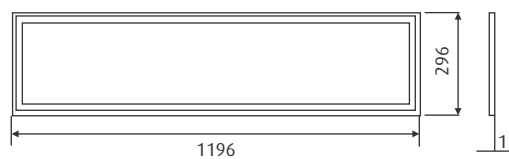

Cutout: 270 mm x 1170 mm

All dimensions are in mm. Tolerance ± 2 mm

ELECTRICAL & PACKING DATA

INGRESS PROTECTION **IP20**

| Cat. No.* | Luminaire Lumen OP (Lm) | Nominal System Wattage (W) | Rated Voltage (V) | Mains Current (A) | Case Lot (in nos) |
|--------------------|-------------------------|----------------------------|-------------------|-------------------|-------------------|
| LM25-361-XXX-65-G1 | 3600 | 36 | 240 | 0.16 | 04 |
| LM25-481-XXX-65-G1 | 3600 | 36 | 240 | 0.16 | 04 |

*Other colour temperatures available on request.

LED is an ever improving and evolving technology. Wipro is committed to bring you the best in LED technology. Data given is representative and can change.

ElateLED | CRCO 10

Recess mounted LED luminaire with complete diffuser



APPLICATIONS



SPECIFICATIONS

- White powder coated housing & frame in CRCA sheet
- High efficiency LED grade diffuser
- High efficacy LEDs for better light output
- Electronic driver pre-wired upto the terminal block
- Designed and manufactured to comply with IS 10322 part 5/Sec 1 19877

INSTALLATION

- Suitable for modular ceiling system

ACCESSORIES

- For Gypsum/POP applications additional frame needs to be ordered separately
- Order 9180P01025 for aluminium or order 9180P01089 for M.S. Case lot 10 pcs/box



DIMENSION DRAWINGS

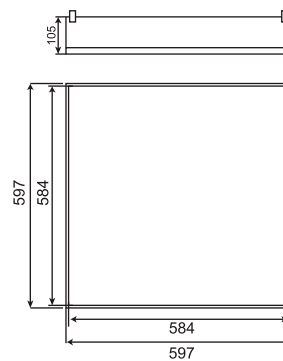

All dimensions are in mm. Tolerance ± 2 mm

ELECTRICAL & PACKING DATA

INGRESS PROTECTION **IP20**

| Cat. No.* | Luminaire Lumen OP (Lm) | Luminaire Wattage (W) | Rated Voltage (V) | Mains Current (A) | Case Lot (in nos) |
|-------------------|-------------------------|-----------------------|-------------------|-------------------|-------------------|
| CRCO10R038HP57GL1 | 3640 | 36 | 240 | 0.18 | 02 |

*57 represents 5700K. Replace 57 with 40 for 4000K

LED is an ever improving and evolving technology. Wipro is committed to bring you the best in LED technology. Data given is representative and can change.



WaveLED | LM 24

Recess mounted direct-indirect LED luminaire



APPLICATIONS



SPECIFICATIONS

- White powder coated CRCA housing and front cover in plastic
- Special virgin grade High Efficiency Translucence (HET) diffuser
- High luminous flux imported LEDs for better light output
- Electronic control gear duly wired up to the terminal block
- Designed and manufactured to comply with IS 10322 part 5/Sec 1 1987

INSTALLATION

- Designed for installation with four nos. of steel hook-up wire suspension to ensure correct leveling within ceiling aperture
- Suitable for Armstrong/CRG/TRAC/ USG/Celotex/ POP**modular ceilings

ACCESSORIES

- CRCA powder coated frame Cat. No. 9180P01089 order seperately
- For POP/Gypsum ceiling cutout dimensions are 608 mm x 608 mm



DIMENSION DRAWINGS

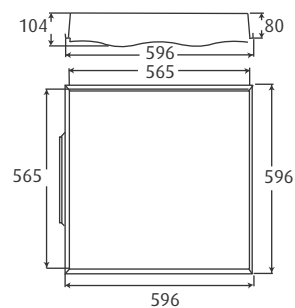

All dimensions are in mm. Tolerance ± 2 mm

ELECTRICAL & PACKING DATA

INGRESS PROTECTION **IP20**

| Cat. No.* | Luminaire Lumen OP (Lm) | Luminaire Wattage (W) | Rated Voltage (V) | Mains Current (A) | Approx. Weight (kg) | Case Lot (in nos) |
|--------------------|-------------------------|-----------------------|-------------------|-------------------|---------------------|-------------------|
| LM24-391-XXX-57-G1 | 3203 | 31 | 240 | 0.14 | 3.8 | 02 |
| LM24-421-XXX-57-G1 | 3303 | 33 | 240 | 0.15 | 3.8 | 02 |

*Other colour temperatures available on request.

LED is an ever improving and evolving technology. Wipro is committed to bring you the best in LED technology. Data given is representative and can change.

SpacioLED | LM 15

Recess mounted indirect-direct LED luminaire for new age workspaces



APPLICATIONS



SPECIFICATIONS

- CRCA powder coated ribbed housing
- Special translucent high transmissivity, polycarbonate diffuser
- Low power, high efficiency LED
- Excellent heat dissipation through direct contact
- Driver pre wired up to terminal block
- Provision for loop in loop out for ease of wiring
- Conforms to IS 10322 / Part 5 /Sec 1 : 2012

ACCESSORIES

- In-built electronic LED driver
- Complete with LEDs and drivers pre-wired up to terminal block
- 3way 10Amps GFP mains connector

INSTALLATION

- Luminaires suitable for Armstrong/GRG/TRAC/USG/Celotex/POP modular ceiling systems
- Luminaire design for installation with four nos. of steel hook-up wire suspension to ensure correct leveling within ceiling aperture
- Simple and rapid installation to save time and effort

DIMENSION DRAWINGS

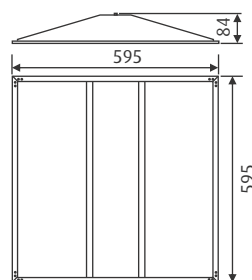

Cutout: 570mm x 570mm

All dimensions are in mm. Tolerance ± 2 mm

ELECTRICAL & PACKING DATA

INGRESS PROTECTION **IP20**

| Cat. No.* | Luminaire Lumen OP (Lm) | Nominal System Wattage (W) | Rated Voltage (V) | Mains Current (A) | Approx Weight (Kg) | Case Lot (in nos) |
|--------------------|-------------------------|----------------------------|-------------------|-------------------|--------------------|-------------------|
| LM15-361-XXX-57-XX | 2579 | 32 | 240 | 0.13 | 3.0 | 02 |
| LM15-411-XXX-57-XX | 3025 | 35 | 240 | 0.18 | 3.0 | 02 |

*Other colour temperatures available on request.

LED is an ever improving and evolving technology. Wipro is committed to bring you the best in LED technology. Data given is representative and can change.



Matrix-ILED | LM 17

Recess mounted LED luminaire



APPLICATIONS



SPECIFICATIONS

- CRCA white powder coated housing
- Special translucent high transmissivity, PMMA diffuser
- High efficiency LED
- Driver pre-wired up to terminal block
- Provision for loop in loop out for ease of wiring
- Conforms to IS 10322/Part 5/Sec 1 : 2012
- In-built electronic LED driver
- Complete with LEDs and drivers pre-wired up to terminal block to connect in coming power
- 3way 10Amps GFP mains connector

INSTALLATION

- Luminaires suitable for Armstrong/GRG/TRAC/USG/Celotex / POP modular ceiling systems
- Luminaire design for installation with four nos. of steel hook-up wire suspension to ensure correct leveling within ceiling cutout
- Simple and rapid installation to save time and effort

ACCESSORIES

- CRCA powder coated frame Cat no. 9180P01089-order separately for POP ceiling installation

DIMENSION DRAWINGS

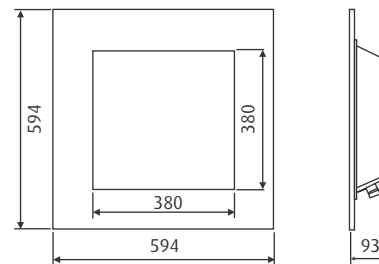

Cutout: 608mm x 608mm

All dimensions are in mm. Tolerance ± 2 mm

ELECTRICAL & PACKING DATA

INGRESS PROTECTION **IP20**

| Cat. No.* | Luminaire Lumen OP (Lm) | Luminaire Wattage (W) | Rated Voltage (V) | Mains Current (A) | Approx. Weight (kg) | Case Lot (in nos) |
|--------------------|-------------------------|-----------------------|-------------------|-------------------|---------------------|-------------------|
| LM17-401-XXX-57-XX | 2802 | 30 | 240 | 0.13 | 3.8 | 02 |
| LM17-461-XXX-57-XX | 3260 | 33 | 240 | 0.14 | 3.8 | 02 |

LED is an ever improving and evolving technology. Wipro is committed to bring you the best in LED technology. Data given is representative and can change.

AxeonLED Recess | LM 34



Recess mounted linear LED luminaire

APPLICATIONS



SPECIFICATIONS

- White powder coated finish extruded aluminium housing
- Special translucent satin finish LED grade diffuser
- Low power, high efficacy long life LEDs
- Excellent heat dissipation
- High Performance LED driver duly wired up to terminal block
- Luminaires are suitable for stand-alone and continuous installation
- Provision for loop in loop out for ease of wiring
- Conforms to IS 10322 part 5/Sec 1 2012

INSTALLATION

- Support bracket with quick onsite adjustment: Suitable POP/Gypsum/Grid

ACCESSORIES

- In-built electronic LED driver
- Complete with LEDs and drivers pre-wired up to terminal block to connect in coming power
- 3way 10Amps GFP mains connector

DIMENSION DRAWINGS

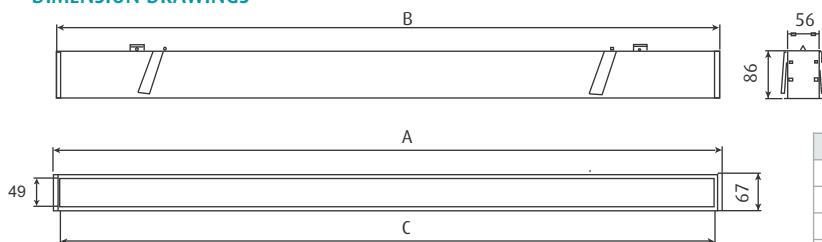

| | A | B | C | POP Cutout |
|---------|------|------|------|------------------------------|
| 4ft Std | 1195 | 1184 | 1171 | 60mm x 1188 mm |
| 4ft CT | 1190 | 1182 | 1171 | 60mm x (No. of units + 5mm) |
| 8ft Std | 2395 | 2384 | 2362 | 60mm x 2388 mm |
| 8ft CT | 2387 | 2382 | 2362 | 60mm x (No. of units + 5mm) |

All dimensions are in mm. Tolerance ± 2 mm

ELECTRICAL & PACKING DATA

INGRESS PROTECTION **IP20**

| Cat. No.* | Length | Luminaire Lumen OP(Lm) | Luminaire Wattage(W) | Rated Voltage(V) | Mains Current(A) | Approx Weight(Kg) | Case Lot(in nos) |
|---------------------|--------|------------------------|----------------------|------------------|------------------|-------------------|------------------|
| LM34-251-XXX-57-RM | 4 ft | 1764 | 20 | 240 | 0.092 | 4.5 | 01 |
| LM34-251-XXX-57RMCT | 4 ft | 1764 | 20 | 240 | 0.092 | 4.5 | 01 |

*57 represents 5700K. Replace 57 with 40 for 4000K. LED is an ever improving and evolving technology. Wipro is committed to bring you the best in LED technology. Data given is representative and can change.



AxeonLED Trimless | LM 34

Recess mounted linear LED luminaire



APPLICATIONS



SPECIFICATIONS

- Product would look neat and clean with thin border
- White powder coated finish extruded aluminium housing
- Special translucent satin finish color LED PMMA diffuser
- Low power, high efficacy long life LEDs
- Excellent heat dissipation through direct contact
- LED driver duly wired up to terminal block
- Luminaires are suitable for stand-alone and continuous trim less installation
- Provision for loop in loop out for ease of wiring
- Conforms to IS 10322 part 5/ Sec 1 2012

INSTALLATION

- Fixed and adjustable brackets are provided for easy mounting on POP/Gypsum/wooden ceilings

ACCESSORIES

- In-built electronic LED driver
- Complete with LEDs and drivers pre-wired up to terminal block to connect in coming power
- 3way 10Amps GFP mains connector

DIMENSION DRAWINGS

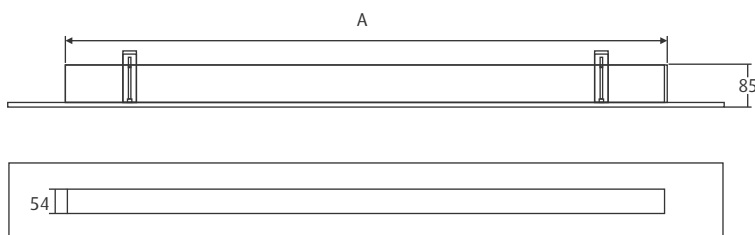

| | A | POP Cutout |
|----------|------|-------------------|
| 4 ft Std | 1180 | 54mm x 1182mm |
| 4 ft CT | 1176 | 54mm x continuous |
| 8 ft Std | 2356 | 54mm x 2358mm |
| 8 ft CT | 2352 | 54mm x continuous |

All dimensions are in mm. Tolerance ± 2 mm

ELECTRICAL & PACKING DATA

INGRESS PROTECTION **IP20**

| Cat No. | Length | Luminaire Lumen OP(Lm) | Luminaire Wattage(W) | Mains Current | Approx Weight (kg) | Case Lot (in nos) |
|--------------------|--------|------------------------|----------------------|---------------|--------------------|-------------------|
| LM34-251-XXX-57-TL | 4 ft | 1764 | 20 | 0.092 | 4.5 | 1 |
| LM34-251XXX-57TLCT | 4 ft | 1764 | 20 | 0.092 | 4.5 | 1 |

*57 represents 5700K. Replace 57 with 40 for 4000K. LED is an ever improving and evolving technology. Wipro is committed to bring you the best in LED technology. Data given is representative and can change.

LineosLED | LM 30

Linear recess mounted LED luminaire



APPLICATIONS



SPECIFICATIONS

- White powder coated aluminium housing
- Special translucent satin finish colour LED PMMA diffuser
- Low power, high efficacy long life LEDs
- Excellent heat dissipation through direct contact
- Complete assembly with LED, driver and accessories pre wired upto terminal block
- Integral covered control gear
- Suitable for indoor application
- Conforms to IS 10322 / Part 5 / Sec 1:1987

INSTALLATION

- Specially designed mounting brackets suitable for 10 to 30 mm thick POP/GYP board ceiling system

CONTROL GEAR

- In-built Electronic LED driver

DIMENSION DRAWINGS

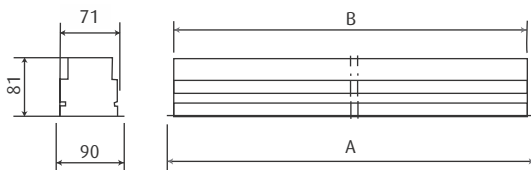

| Cat No. | Dimension A (mm) | Dimension B (mm) |
|--------------------|------------------|------------------|
| LM30-211-XXX-57-XX | 1195 | 21 |
| LM30-211-XXX-57-CT | 1185 | 21 |
| LM30-401-XXX-57-XX | 1195 | 30 |
| LM30-401-XXX-57-CT | 1185 | 30 |

Cutout: 1178mm x 78mm

All dimensions are in mm. Tolerance ± 2 mm

ELECTRICAL & PACKING DATA

INGRESS PROTECTION **IP20**

| Cat. No.* | Luminaire Lumen OP (Lm) | Nominal System Wattage (W) | Rated Voltage (V) | Mains Current (A) | Approx. Weight (kg) | Case Lot (in nos) |
|--------------------|-------------------------|----------------------------|-------------------|-------------------|---------------------|-------------------|
| LM30-211-XXX-57-XX | 1554 | 21 | 240 | 0.092 | 2.7 | 01 |
| LM30-211-XXX-57-CT | 1554 | 21 | 240 | 0.092 | 2.7 | 01 |
| LM30-401-XXX-57-XX | 2830 | 32 | 240 | 0.13 | 2.7 | 01 |
| LM30-401-XXX-57-CT | 2830 | 32 | 240 | 0.13 | 2.7 | 01 |

*Other colour temperatures available on request. LED is an ever improving and evolving technology. Wipro is committed to bring you the best in LED technology. Data given is representative and can change.



Aura Plus | CRCO 13

Recess/surface mounted LED luminaire



APPLICATIONS



SPECIFICATIONS

- CRCA white powder coated housing with CRCA cover
- High Efficiency Translucence (HET) diffuser for better light diffusion
- High efficacy and long life LEDs for better light output
- Easy to mount with suspension kit
- Electronic driver duly wired up to the terminal block
- Designed and manufactured to comply with IS 10322 part 5/Sec 1 2012

INSTALLATION

- Suitable for Grid/Armstrong/POP modular ceiling systems

DIMENSION DRAWINGS

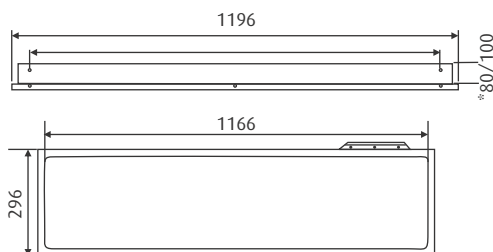

For 36W luminaire, height is 80mm. For 38W luminaire, height is 100mm

All dimensions are in mm. Tolerance ± 2 mm

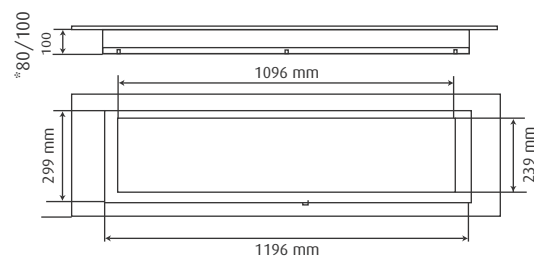

ELECTRICAL & PACKING DATA

INGRESS PROTECTION **IP20**

| Cat. No.* | Luminaire Lumen OP (Lm) | Luminaire Wattage (W) | Rated Voltage (V) | Mains Current (A) | Approx. Weight (kg) | Case Lot (in nos) |
|------------------|-------------------------|-----------------------|-------------------|-------------------|---------------------|-------------------|
| CRCO13R038HP57G1 | 3000 | 31 | 240 | 0.14 | 3.8 | 02 |
| CRCO13S038HP57G1 | 3000 | 31 | 240 | 0.14 | 4.0 | 02 |

*'R' represents recess and 'S' represents surface mounting

*57 represents 5700K. Replace 57 with 40 for 4000K

LED is an ever improving and evolving technology. Wipro is committed to bring you the best in LED technology. Data given is representative and can change.

TZLED | LM 35

Recess mounted slim LED luminaire suitable for TechZone™ ceiling



APPLICATIONS



SPECIFICATIONS

- Down lighting with high efficacy long life LEDs
- Extruded white powder coated aluminium housing with die-cast end cap
- Special translucent satin finish PMMA diffuser
- Suitable for stand-alone and continuous row installation
- Driver and accessories pre-wired up to the terminal block
- Designed and manufactured to comply with IS 10322 part 5/Sec 1 1987

INSTALLATION

- Suitable for Armstrong TechZone™ ceiling

DIMENSION DRAWINGS

Stand-alone installation

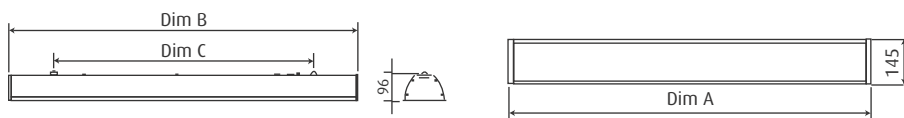

Continuous row installation

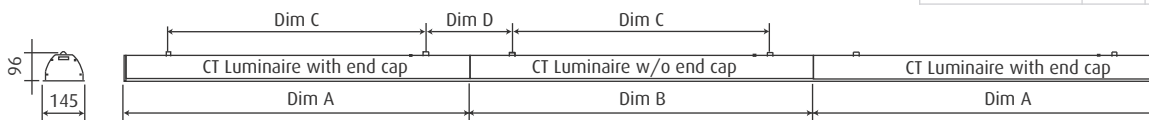

| Product Dimensions & Mounting Details | | | | |
|---------------------------------------|-------|-------|-------|-------|
| Cat No. | Dim A | Dim B | Dim C | Dim D |
| LM35-381-XXX-57-G1 | 1195 | 1179 | 880 | NA |
| LM35-761-XXX-57-G1 | 2395 | 2379 | 2080 | NA |
| LM35-381-XXX-57-CT | 1185 | 1175 | 880 | 295 |
| LM35-761-XXX-57-CT | 2385 | 2375 | 2080 | 295 |

Cutout: 1178mm x 133mm

All dimensions are in mm. Tolerance ± 2 mm

ELECTRICAL & PACKING DATA

INGRESS PROTECTION **IP20**

| Cat. No.* | Luminaire Lumen OP (Lm) | Nominal System Wattage (W) | Rated Voltage (V) | Mains Current (A) | Approx. Weight (kg) | Case Lot (in nos) |
|--------------------|-------------------------|----------------------------|-------------------|-------------------|---------------------|-------------------|
| LM35-381-XXX-57-G1 | 2500 | 28 | 240 | 0.12 | 4.0 | 02 |
| LM35-381-XXX-57-CT | 2500 | 28 | 240 | 0.12 | 4.0 | 02 |
| LM35-761-XXX-57-G1 | 5000 | 56 | 240 | 0.24 | 8.0 | 01 |
| LM35-761-XXX-57-CT | 5000 | 56 | 240 | 0.24 | 8.0 | 01 |

*Other colour temperatures available on request. Product Code with G1 for Standalone installation and CT for continuous row installation

LED is an ever improving and evolving technology. Wipro is committed to bring you the best in LED technology. Data given is representative and can change.







AxeonLED Drop Down | LM 34

Suspended Linear LED luminaire with drop down diffuser



APPLICATIONS



SPECIFICATIONS

- White powder coated finish extruded aluminium housing
- Special translucent satin finish LED grade diffuser
- Low power, high efficacy long life LEDs
- Excellent heat dissipation
- High performance LED driver duly wired up to terminal block
- Luminaires are suitable for stand-alone and continuous installation
- Provision for loop in loop out for ease of wiring
- Conforms to IS 10322 part 5/ Sec 1 2012

INSTALLATION

- Suitable for suspended and surface mounted application

ACCESSORIES

- In-built electronic LED driver
- Complete with LEDs and drivers pre-wired up to terminal block to connect in coming power
- 3way 10Amps GFP mains connector

DIMENSION DRAWINGS

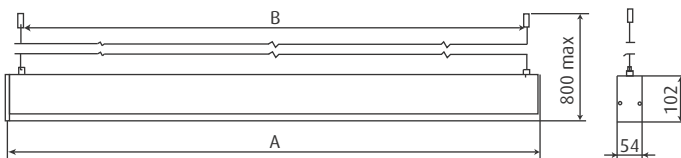

| CAT NO. | DIM A | DIM B |
|----------------------|-------|-------|
| LM34-251-XXX-57-DD | 1180 | 1120 |
| LM34-501-XXX-57-DD | 2355 | 2300 |
| LM34-251-XXX-57-DDCT | 1180 | 1120 |
| LM34-501-XXX-57-DDCT | 2355 | 2300 |

All dimensions are in mm. Tolerance ± 2 mm

ELECTRICAL & PACKING DATA

INGRESS PROTECTION **IP20**

| Cat. No.* | Length | Luminaire Lumen OP (Lm) | Luminaire Wattage (W) | Rated Voltage (V) | Mains Current (A) | Approx Weight (Kg) | CaseLot (in nos) |
|--------------------|--------|-------------------------|-----------------------|-------------------|-------------------|--------------------|------------------|
| LM34-251-XXX-57-DD | 4 feet | 1764 | 20 | 240 | 0.09 | 4.5 | 01 |
| LM34-251XXX-57DDCT | 4 feet | 1764 | 20 | 240 | 0.09 | 4.5 | 01 |
| LM34-501-XXX-57-DD | 8 feet | 3528 | 40 | 240 | 0.18 | 9.0 | 01 |
| LM34-501XXX-57DDCT | 8 feet | 3528 | 40 | 240 | 0.18 | 9.0 | 01 |

*57 represents 5700K. Replace 57 with 40 for 4000K.

LED is an ever improving and evolving technology. Wipro is committed to bring you the best in LED technology. Data given is representative and can change.

AxeonLED | LM 34

Linear suspended up-down light, LED luminaire

APPLICATIONS



FEATURES & BENEFITS

Uniform illumination

Special High Efficiency Translucence (HET) diffuser provides wide and horizontal light distribution across horizontal and vertical surfaces enhancing the beauty of the environment.

Up-Down lighting

Separate upward and downward light component in the luminaire helps in distributing light uniformly. 33% up & 66% downward light distribution gives a spacious and distinctive look to the workspaces.

High Efficacy LEDs

Excellent luminaire design along with low power, high efficacy LEDs contribute to 50% energy savings. It also addresses the need of good quality lighting and long life for the luminaire.



SPECIFICATIONS

- White powder coated finish extruded aluminium housing
- Special translucent satin finish colour LED PMMA diffuser
- 33% up & 66% downward light distribution
- Low power, high efficacy long life LEDs
- Excellent heat dissipation through direct contact
- LED driver duly wired up to terminal block
- Luminaires are suitable for stand alone and continuous row installation
- Also available in 90° and 120° connectivity
- 90° and 120° connectivity options available in Axeon downlight Luminaire
- For Axeon Updown Luminaire – 4ft and 8ft Luminaire length options available
- For Axeon Downlight Luminaire – 2ft, 3ft, 4ft, 6ft and 8ft length options available
- Provision for loop in loop out for ease of wiring
- Conforms to IS 10322 part 5/ Sec 1 1987

DIMENSION DRAWINGS

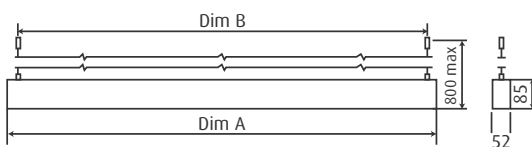

All dimensions are in mm. Tolerance ± 2 mm

| Product Dimensions | | |
|-----------------------|-------|-----------|
| Cat. No. | Dim A | Mtg Dim B |
| LM34-361-XXX-57-XX/CT | 1180 | 1120 |
| LM34-721-XXX-57-XX/CT | 2355 | 2300 |

Get in touch with Wipro team for more information

INSTALLATION

Suspension system with quick onsite adjustment:

- LMX 341 suitable for installation on RCC ceiling
- LMX 342 suitable for installation on modular grid Prelude 24mm ceiling system
- LMX 343 suitable for installation on modular grid Silhouette 15mm ceiling system

ACCESSORIES

- In-built electronic LED driver
- Complete with LEDs and drivers pre-wired up to terminal block to connect in coming power
- 3way 10 Amps GFP mains connector

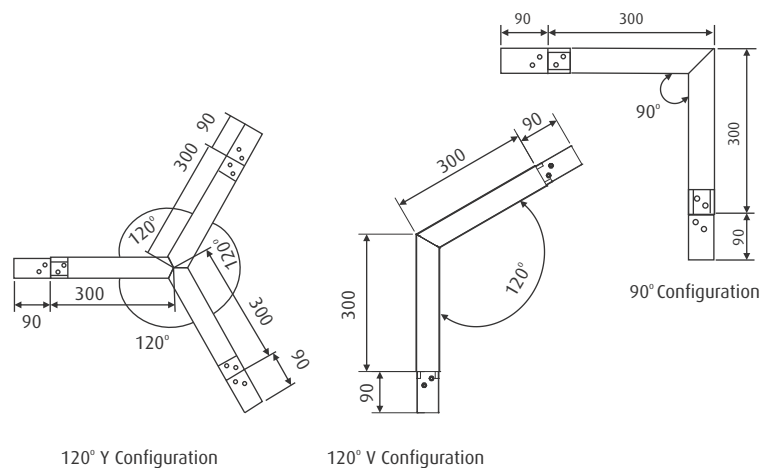

ELECTRICAL & PACKING DATA

INGRESS PROTECTION IP20

| Cat. No.* | Luminaire Lumen OP (Lm) | Luminaire Wattage (W) | Rated Voltage (V) | Mains Current (A) | Approx Weight (KG) | Case Lot (in nos) |
|-----------------------|-------------------------|-----------------------|-------------------|-------------------|--------------------|-------------------|
| LM34-361-XXX-57-XX/CT | 2595 | 29 | 240 | 0.13 | 3.6 | 01 |
| LM34-721-XXX-57-XX/CT | 4600 | 58 | 240 | 0.26 | 7.1 | 01 |
| LM34-251-XXX-57-XX/CT | 1750 | 20 | 240 | 0.10 | 3.5 | 01 |
| LM34-501-XXX-57-XX/CT | 3500 | 40 | 240 | 0.20 | 7.0 | 01 |
| LM34-371-90L-57-12 | 2600 | 26 | 240 | 0.11 | 3.6 | 01 |
| LM34-371-120V57-12** | 2600 | 26 | 240 | 0.11 | 3.6 | 01 |
| LM34-551-120Y57-12** | 3900 | 39 | 240 | 0.17 | 3.6 | 01 |

**For Length of 1050mm, replace "12" with "10" in product code

*Order product code with XX for stand-alone installation and CT for end-to-end installation. 57 represents 5700K.

LED is an ever improving and evolving technology. Wipro is committed to bring you the best in LED technology. Data given is representative and can change.



PieLED | LM 78

Linear up-down suspended light, LED luminaire

APPLICATIONS



FEATURES & BENEFITS

360 degree illuminance

Its unique optical system creates volumetric lighting. PieLED's upward-downward lighting ensures uniform light, creating a relaxed and stress-free work environment.

Seamless connection

PieLED with its straight crisp profile seamlessly connects and aligns with the architecture. Unique, specially designed optics gives modern workspaces the undivided attention.

Ease of Maintenance

PieLED snap-fit diffuser helps in removing and maintaining the diffuser. The height adjustment mechanism provides the flexibility in installing the product



SPECIFICATIONS

- Extruded pure white powder coated aluminium housing with die-cast end caps
- Up-down lighting with high efficacy LEDs
- Special translucent satin finish coloured LED PMMA diffuser
- Suitable for stand-alone and continuous row installation
- LED driver and accessories pre-wired up to terminal block
- Conforms to IS 10322 part 5/Sec 1 1987

INSTALLATION

Universal suspension system with quick onsite adjustment:

- Mounting with 2 nos. suspensions from ceiling WVX 861 suitable for installation on RCC ceiling
- WVX 862 suitable for installation on modular grid Armstrong (Prelude 24mm exposed suspension system)
- WVX 863 suitable for installation on modular grid Armstrong (Silhouette 15mm)

DIMENSION DRAWINGS

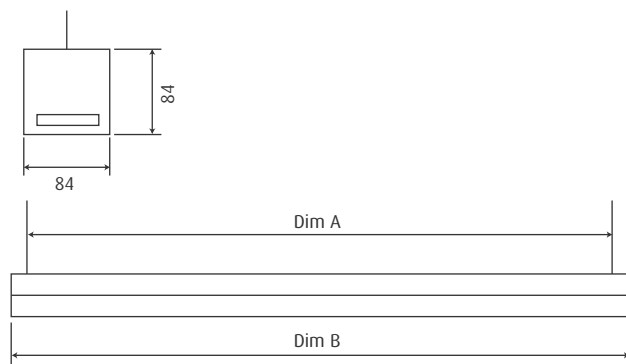

All dimensions are in mm. Tolerance ± 2 mm

| Cat No. | DIM A | DIM B |
|--------------------|-------|-------|
| LM78-401-XXX-57-XX | 1160 | 1204 |
| LM78-801-XXX-57-XX | 2360 | 2404 |
| LM78-401-XXX-57-CT | 1180 | 1202 |
| LM78-801-XXX-57-CT | 2380 | 2402 |

ELECTRICAL & PACKING DATA

INGRESS PROTECTION **IP20**

| Cat. No.* | Luminaire Lumen OP (Lm) | Luminaire Wattage (W) | Rated Voltage (V) | Mains Current (A) | Approx Weight (KG) | Case Lot (in nos) |
|-----------------------|-------------------------|-----------------------|-------------------|-------------------|--------------------|-------------------|
| LM78-401-XXX-57-XX/CT | 2944 | 26 | 240 | 0.12 | 4.0 | 01 |
| LM78-801-XXX-57-XX/CT | 5887 | 52 | 240 | 0.24 | 8.0 | 01 |

*Order product code with XX for stand-alone installation and CT for end-to-end installation. 57 represents 5700K. Replace 57 with 40 for 4000K.

LED is an ever improving and evolving technology. Wipro is committed to bring you the best in LED technology. Data given is representative and can change.

AslimlineLED | LM 77

The slimmest luminaire in class

APPLICATIONS



FEATURES & BENEFITS

Edge lit Technology

Edge Lit technology has finally helped us to develop a state of art Edge Lit configuration for optics. Thus creates slim products with better light efficiency.

Elegant profile

The slim linear proportions with sharp aesthetics make the product look dynamic and elegant

Seamless diffuser

Open ended diffuser assembly gives the product an endless appeal making the product look light weight and eye catching.



SPECIFICATIONS

- Extruded aluminum powder coated housing with pressure die cast end caps
- Edge lit optics derived from reflector+ light guide plate+ diffuser configuration
- Low wattage high efficiency LEDs
- Excellent heat dissipation through direct contact
- CRCA powder coated control gear housing
- Luminaires are suitable for stand alone and continuous row installation
- Conforms to IS 10322/Part 5/Sec 1 : 1987

INSTALLATION

- Universal suspension system with quick onsite adjustment:

LMX 771 suitable for installation on RCC ceiling

LMX 772 suitable for installation on modular grid Armstrong prelude ceiling

LMX 773 suitable for installation on modular grid Armstrong silhouette ceiling

DIMENSION DRAWINGS

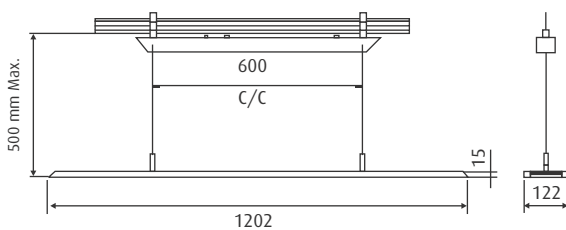

All dimensions are in mm. Tolerance ± 2 mm

ACCESSORIES

- In-built electronic LED driver
- Complete with LEDs and drivers pre-wired up to terminal block to connect in coming power
- 3way 10Amps GFP mains connector

ELECTRICAL & PACKING DATA

INGRESS PROTECTION **IP20**

| Cat. No.* | Luminaire Lumen OP (Lm) | Luminaire Wattage (W) | Rated Voltage (V) | Mains Current (A) | Approx Weight (KG) | Case Lot (in nos) |
|--------------------|-------------------------|-----------------------|-------------------|-------------------|--------------------|-------------------|
| LM77-441-XXX-57-V1 | 2743 | 32 | 240 | 0.13 | 2.7 | 02 |
| LM77-441-XXX-40-V1 | 2590 | 32 | 240 | 0.13 | 2.7 | 02 |

*Other colour temperatures available on request.

LED is an ever improving and evolving technology. Wipro is committed to bring you the best in LED technology. Data given is representative and can change.

LineosLED | LM 31

Linear suspended LED luminaire



APPLICATIONS



SPECIFICATIONS

- Aluminium extruded powder coated white housing
- Special translucent satin finish colourLED PMMA diffuser.
- Low power, high efficacy long life LEDs
- Excellent heat dissipation through direct contact
- Complete assembly with LED, Driver and accessories pre wired upto terminal block
- Integral covered control gear
- Conforms to IS 10322/Part 5/Sec 1:1987

INSTALLATION

- WVX 861 - suitable for installation on RCC ceiling
- WVX 862 - suitable for installation on modular grid Prelude 24 mm ceiling system
- WVX 863 - suitable for installation on modular grid Silhouette 15mm ceiling system

CONTROL GEAR

- In-built Electronic LED driver

DIMENSION DRAWINGS

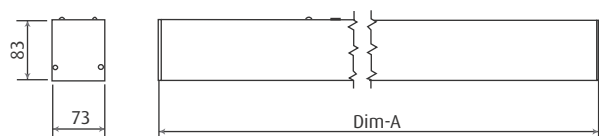

| Cat No. | Dimension A (mm) | Dimension B (mm) |
|--------------------|------------------|------------------|
| LM31-211-XXX-57-XX | 1180 | 21 |
| LM31-211-XXX-57-CT | 1180 | 21 |
| LM31-401-XXX-57-XX | 1180 | 30 |
| LM31-401-XXX-57-CT | 1180 | 30 |

All dimensions are in mm. Tolerance ± 2 mm

ELECTRICAL & PACKING DATA

INGRESS PROTECTION **IP20**

| Cat. No.* | Luminaire Lumen OP (Lm) | Luminaire Wattage (W) | Rated Voltage (V) | Mains Current (A) | Approx. Weight (kg) | Case Lot (in nos) |
|--------------------|-------------------------|-----------------------|-------------------|-------------------|---------------------|-------------------|
| LM31-211-XXX-57-XX | 1554 | 21 | 240 | 0.092 | 2.7 | 01 |
| LM31-211-XXX-57-CT | 1554 | 21 | 240 | 0.092 | 2.7 | 01 |
| LM31-401-XXX-57-XX | 2830 | 32 | 240 | 0.13 | 2.7 | 01 |
| LM31-401-XXX-57-CT | 2830 | 32 | 240 | 0.13 | 2.7 | 01 |

*Other colour temperatures available on request. LED is an ever improving and evolving technology. Wipro is committed to bring you the best in LED technology. Data given is representative and can change.



AxeonLED Surface | LM 34

Surface mounted linear LED luminaire



APPLICATIONS



SPECIFICATIONS

- White powder coated finish extruded aluminium housing
- Special translucent satin finish LED grade diffuser
- Low power, high efficacy long life LEDs
- Excellent heat dissipation
- LED driver duly wired up to terminal block
- Luminaires are suitable for stand-alone and continuous surface mounted installation
- Provision for loop in loop out for ease of wiring
- Conforms to IS 10322 part 5/ Sec 1 2012

INSTALLATION

- Surface mounted brackets are provided for easy mounting on true ceiling

ACCESSORIES

- In-built electronic LED driver
- Complete with LEDs and drivers pre-wired up to terminal block to connect in coming power
- 3way 10Amps GFP mains connector

DIMENSION DRAWINGS

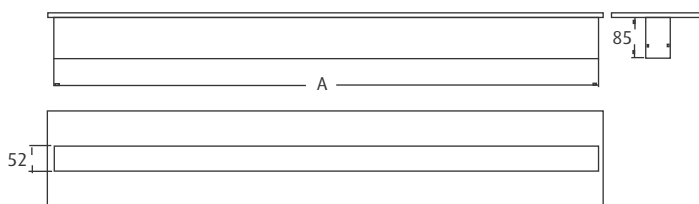

| | A |
|---------|------|
| 4th Std | 1180 |
| 4ft CT | 1176 |
| 8th Std | 2356 |
| 8th CT | 2352 |

All dimensions are in mm. Tolerance ± 2 mm

ELECTRICAL & PACKING DATA

INGRESS PROTECTION **IP20**

| Cat. No.* | Luminaire Lumen OP (Lm) | Luminaire Wattage (W) | Rated Voltage (V) | Mains Current (A) | Approx Weight (KG) | Case Lot (in nos) |
|--------------------|-------------------------|-----------------------|-------------------|-------------------|--------------------|-------------------|
| LM34-251-XXX-57-SM | 1764 | 20 | 240 | 0.092 | 4.5 | 01 |

*57 represents 5700K. Replace 57 with 40 for 4000K. LED is an ever improving and evolving technology. Wipro is committed to bring you the best in LED technology. Data given is representative and can change.

LH13 LED | LH 13

Pendant mounted LED luminaire with spun aluminium reflector

APPLICATIONS



FEATURES & BENEFITS

Design and Aesthetics

Compact design with aluminium die-cast construction for sturdy performance.

Optics

High efficiency reflector optics with choice of beam angles - very narrow, narrow, medium, wide.

LEDs

Best-in-class LED technology. High efficiency, LM80 compliant LEDs.

Thermal management

Designed for effective thermal management ensuring long service life and consistent performance of LEDs.



SPECIFICATIONS

- Extruded aluminum housing
- Aluminium reflector
- Best in class LEDs for better efficiency and light output
- Effective thermal management using aluminium casting
- High performance driver
- Suitable for accent and function lighting

INSTALLATION

- Suitable for mounting on RCC ceiling
- Standard offering with 1m suspension system

DIMENSION DRAWINGS

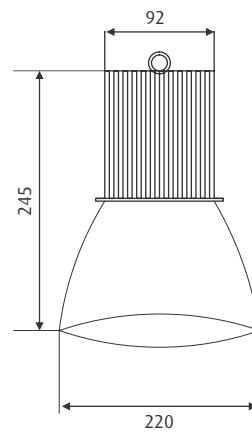

All dimensions are in mm. Tolerance ± 2 mm

ELECTRICAL & PACKING DATA

INGRESS PROTECTION **IP20**

| Cat. No.* | Luminaire Lumen OP (Lm) | Nominal System Wattage (W) | Rated Voltage (V) | Mains Current (A) |
|--------------------|-------------------------|----------------------------|-------------------|-------------------|
| LH13-301-060-40-XX | 2880 | 32 | 240 | 0.14 |
| LH13-301-060-57-XX | 3070 | 32 | 240 | 0.14 |

LED is an ever improving and evolving technology. Wipro is committed to bring you the best in LED technology. Data given is representative and can change.

OrbitLED | LM 71

Circular suspended fully diffused LED luminaire



APPLICATIONS



SPECIFICATIONS

- High efficacy and long life LEDs
- Housing made of CRCA and white matt powder coated
- High Efficiency Translucence(HET) diffuser made of PMMA(acrylic) milky white
- Suspension system made of steel wire of 2mm dia and accessories are chrome plated Or conduit made of MS pipe and white powder coated
- Easy to mount on true ceiling and quick to service
- Electronic control gear duly wired up to the terminal block
- Designed and manufactured to comply with IS 10322 part 5/Sec 1 1987

INSTALLATION

- Suitable for indoor suspended application

DIMENSION DRAWINGS

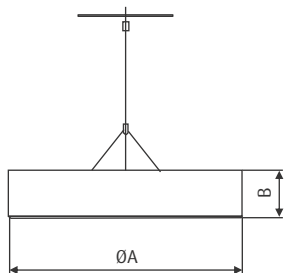

All dimensions are in mm. Tolerance ± 2 mm

| Cat No. | DIM A | DIM B |
|--------------------|-------|-------|
| LM71-441-XXX-57-XX | 500 | 100 |
| LM71-441-XXX-40-XX | 500 | 100 |
| LM71-341-XXX-57-XX | 300 | 90 |
| LM71-341-XXX-40-XX | 300 | 90 |

ELECTRICAL & PACKING DATA

INGRESS PROTECTION **IP20**

| Cat. No.* | Luminaire Lumen OP (Lm) | Nominal System Wattage (W) | Rated Voltage (V) | Mains Current (A) | Approx Weight (kg) | Case Lot (in nos) |
|--------------------|-------------------------|----------------------------|-------------------|-------------------|--------------------|-------------------|
| LM71-341-XXX-40-XX | 1855 | 26 | 240 | 0.12 | 4.25 | 01 |
| LM71-441-XXX-40-XX | 2626 | 34 | 240 | 0.15 | 4.25 | 01 |

*40 represents 4000K. Replace 40 with 57 for 5700K.

LED is an ever improving and evolving technology. Wipro is committed to bring you the best in LED technology. Data given is representative and can change.



ComfortLED | LW 04

Wall mounted personal LED luminaire



APPLICATIONS



SPECIFICATIONS

- Patient Bedlight system with 2 options :
Individual glare free downlight for reading and examination
Individual up lighting for ambient lighting
- Extruded aluminium housing finish in off-white powder coated
- Diffuser in virgin, non-yellowing, precisely profiled extruded ribbed PMMA
- Translucence PMMA diffuser for Up & lighting and down lighting
- End cap in injection moulded engineering plastics
- Self-illuminated rocker switches
- High efficiency LEDs
- High performance LED driver pre-wired up to terminal block
- Conforms to IS 10322/Part 5/Sec 1 : 1987

INSTALLATION

- Fixing on wall via two key slots provided on the back side C.G. Tray

DIMENSION DRAWINGS

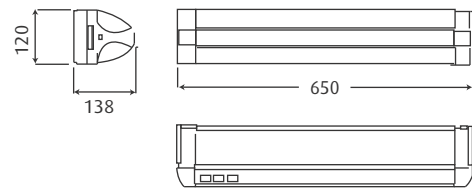

All dimensions are in mm. Tolerance ± 2 mm

ELECTRICAL & PACKING DATA

INGRESS PROTECTION **IP20**

| Cat. No.* | Luminaire Lumen OP (Lm) | Luminaire Wattage (W) | Rated Voltage (V) | Mains Current (A) | Case Lot (in nos) |
|--------------------|-------------------------|-----------------------|-------------------|-------------------|-------------------|
| LW04-411-XXX-57-XX | 2533 | 31 | 240 | 0.14 | 01 |

31- (10W up, 20W down, 0.5W LED)

LED is an ever improving and evolving technology. Wipro is committed to bring you the best in LED technology. Data given is representative and can change.





commercial interiors





HelixLED | LD 91

Recess mounted circular LED downlighter



APPLICATIONS



SPECIFICATIONS

- Pressure Die cast aluminium housing
- High efficacy LEDs
- High Transmittivity Diffuser
- Specially designed, easy to install mounting clips
- Driver and accessories are pre-wired

INSTALLATION

- Provision for mounting with the help of specially designed mounting clips

DIMENSION DRAWINGS

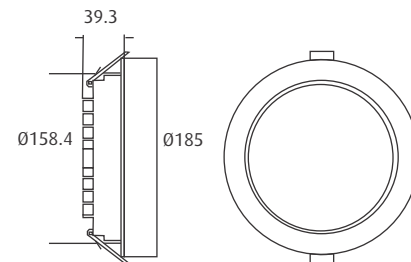

Cutout Dimension: Ø165mm
 All dimensions are in mm. Tolerance ± 2 mm

ELECTRICAL & PACKING DATA

INGRESS PROTECTION **IP20**

| Cat. No.* | Luminaire Lumen OP (Lm) | Nominal System Wattage (W) | Rated Voltage (V) | Mains Current (A) | Approx. Weight (kg) | Case Lot (in nos) |
|--------------------|-------------------------|----------------------------|-------------------|-------------------|---------------------|-------------------|
| LD91-141-XXX-65-XX | 1045 | 11 | 240 | 0.05 | 0.54 | 20 |
| LD91-201-XXX-65-XX | 1425 | 15 | 240 | 0.07 | 0.54 | 20 |

65 stands for 6500K. Replace 65 with 40 to get 4000K.

LED is an ever improving and evolving technology. Wipro is committed to bring you the best in LED technology. Data given is representative and can change.





HeliosLED | LD 90

High performance recess mounted LED downlighter



APPLICATIONS



SPECIFICATIONS

- Pressure die-cast aluminium housing
- High transmittivity PC diffuser
- Specially designed, easy to install mounting clips
- Integrated driver & accessories pre-wired
- High efficacy LEDs
- IS 10322 part5/Sec 1 1987 comply

INSTALLATION

- Provision for mounting with the help of specially designed mounting clips

DIMENSION DRAWINGS

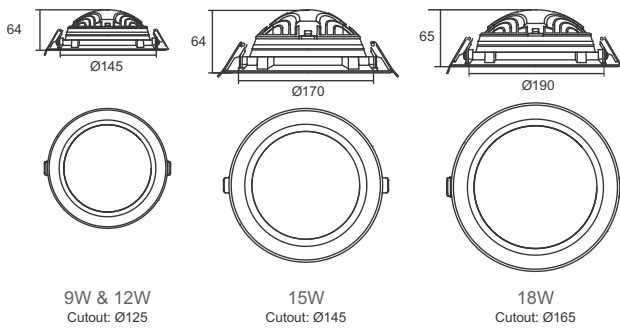

9W & 12W
Cutout: Ø125

15W
Cutout: Ø145

18W
Cutout: Ø165



Redefine your workspaces with better illumination and higher savings

- High performance with >95 lumens/W system efficiency
- Glare-free good quality lighting creating cheerful environment
- Specially designed housing ensuring effective thermal management & long service life

ELECTRICAL & PACKING DATA

INGRESS PROTECTION **IP20**

| Cat. No.* | Luminaire Lumen OP (Lm) | Nominal System Wattage (W) | Rated Voltage (V) | Mains Current (A) | Case Lot (in nos) |
|--------------------|-------------------------|----------------------------|-------------------|-------------------|-------------------|
| LD90-111-XXX-65-XX | 855 | 9 | 240 | 0.04 | 16 |
| LD90-141-XXX-65-XX | 1140 | 12 | 240 | 0.06 | 16 |
| LD90-191-XXX-65-XX | 1425 | 15 | 240 | 0.07 | 16 |
| LD90-231-XXX-65-XX | 1710 | 18 | 240 | 0.08 | 16 |

*Other colour temperatures available on request.

LED is an ever improving and evolving technology. Wipro is committed to bring you the best in LED technology. Data given is representative and can change.

IrisLED | LD 71

Recess mounted circular LED downlighter



APPLICATIONS



SPECIFICATIONS

- High efficiency SMD-LED module
- High transmittivity polycarbonate diffuser white powder coated, pressure die-cast aluminium for superior thermal performance
- Aesthetic white rim molded in engineering plastic
- Specially designed, easy to install mounting clips
- Driver pre-wired up to terminal block

INSTALLATION

- Suitable for Armstrong / CRG / TRAC / USG / Celotex / POP modular ceiling system
- Provision for mounting with the help of specially designed mounting clips
- Suitable for ceiling thickness from 6-19 mm

CONTROL GEAR

- Electronic LED driver

DIMENSION DRAWINGS

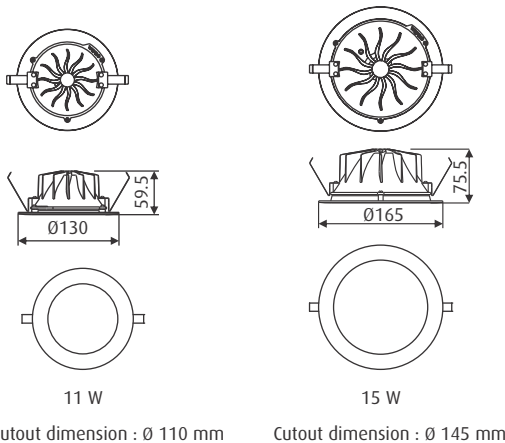

ELECTRICAL & PACKING DATA

INGRESS PROTECTION **IP20**

| Cat. No.* | Luminaire Lumen OP (Lm) | Nominal System Wattage (W) | Rated Voltage (V) | Mains Current (A) | Case Lot (in nos) |
|--------------------|-------------------------|----------------------------|-------------------|-------------------|-------------------|
| LD71-111-SMS-65-XX | 825 | 11 | 240 | 0.04 | 12 |
| LD71-161-SML-65-XX | 1125 | 15 | 240 | 0.06 | 12 |

65 stands for 6500K. Replace 57 and 40 with 65 to get 5700K and 4000K respectively

LED is an ever improving and evolving technology. Wipro is committed to bring you the best in LED technology. Data given is representative and can change.



IrisLED SQ | LD 74

High efficiency square LED downlighter



APPLICATIONS



SPECIFICATIONS

- White powder coated extruded aluminum frame
- High power high efficiency LED module
- Special reflector system with translucent, high transmittivity, non-yellowing diffuser
- LED chips directly mounted on heat sink using thermal paste for effective heat transfer
- Excellent heat dissipation through high purity high thermal conductivity Aluminum heat sink
- Driver pre-wired up to terminal block
- Specially designed mounting clips

INSTALLATION

- Suitable for Armstrong/CRG/TRAC/USG/Celotex/POP modular ceiling system
- Provision for mounting with the help of specially designed mounting clips
- Suitable for ceiling thickness from 6-19 mm

CONTROL GEAR

- Electronic LED driver

DIMENSION DRAWINGS

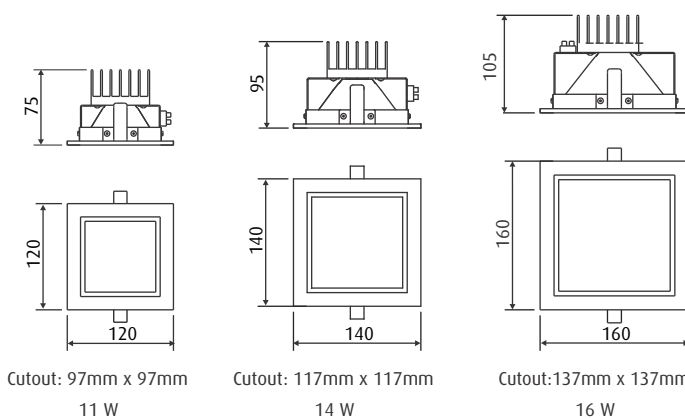

ELECTRICAL & PACKING DATA

INGRESS PROTECTION **IP20**

| Cat. No.* | Luminaire Lumen OP (Lm) | Nominal System Wattage (W) | Rated Voltage (V) | Mains Current (A) | Case Lot (in nos) |
|--------------------|-------------------------|----------------------------|-------------------|-------------------|-------------------|
| LD74-101-XXX-65-XX | 766 | 11 | 240 | 0.05 | 8 |
| LD74-121-XXX-65-XX | 960 | 14 | 240 | 0.06 | 8 |
| LD74-151-XXX-65-XX | 1160 | 16 | 240 | 0.07 | 8 |

*Other colour temperatures available on request.

LED is an ever improving and evolving technology. Wipro is committed to bring you the best in LED technology. Data given is representative and can change.

IrisLED GOLD RF | LD 71

Recess mounted circular LED retrofit downlighter



APPLICATIONS



SPECIFICATIONS

- High efficiency SMD-LED module
- High transmittivity polycarbonate diffuser white powder coated, pressure die-cast aluminium for superior thermal performance
- Aesthetic white rim molded in engineering plastic
- Specially designed, easy to install mounting clips
- Driver pre-wired up to terminal block

INSTALLATION

- Suitable for Armstrong / CRG / TRAC / USG / Celotex / POP modular ceiling system
- Provision for mounting with the help of specially designed mounting clips
- Suitable for ceiling thickness from 6-19 mm

CONTROL GEAR

- Electronic LED driver

DIMENSION DRAWINGS

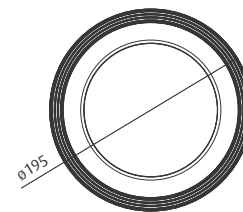
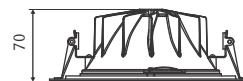

Cutout : 168

All dimensions are in mm. Tolerance ± 2 mm



ELECTRICAL & PACKING DATA

INGRESS PROTECTION **IP20**

| Cat. No.* | Luminaire Lumen OP (Lm) | Nominal System Wattage (W) | Rated Voltage (V) | Mains Current (A) | Case Lot (in nos) |
|--------------------|-------------------------|----------------------------|-------------------|-------------------|-------------------|
| LD71-111-SML-65-RF | 825 | 11 | 240 | 0.17 | 12 |
| LD71-161-SML-65-RF | 1125 | 15 | 240 | 0.35 | 12 |

65 stands for 6500K. Replace 57 and 40 with 65 to get 5700K and 4000K respectively

LED is an ever improving and evolving technology. Wipro is committed to bring you the best in LED technology. Data given is representative and can change.



IrisLED GOLD DD | LD 71

High efficiency LED downlighter with drop down diffuser



APPLICATIONS



SPECIFICATIONS

- High efficiency SMD-LED module
- High transmittivity polycarbonate diffuser white powder coated, pressure die-cast aluminium for superior thermal performance
- Aesthetic white rim molded in engineering plastic
- Specially designed, easy to install mounting clips
- Driver pre-wired up to terminal block

INSTALLATION

- Suitable for Armstrong / CRG / TRAC / USG / Celotex / POP modular ceiling system
- Provision for mounting with the help of specially designed mounting clips
- Suitable for ceiling thickness from 6-19 mm

CONTROL GEAR

- Electronic LED driver



DIMENSION DRAWINGS

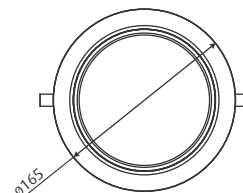
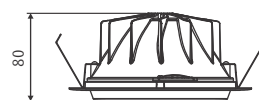

Cutout : 145

All dimensions are in mm. Tolerance ± 2 mm

ELECTRICAL & PACKING DATA

INGRESS PROTECTION **IP20**

| Cat. No.* | Luminaire Lumen OP (Lm) | Nominal System Wattage (W) | Rated Voltage (V) | Mains Current (A) | Approx. Weight (kg) | Case Lot (in nos) |
|--------------------|-------------------------|----------------------------|-------------------|-------------------|---------------------|-------------------|
| LD71-111-SML-65-DD | 825 | 11 | 240 | 0.17 | 0.37 | 12 |
| LD71-161-SML-65-DD | 1125 | 15 | 240 | 0.35 | 0.50 | 12 |

65 stands for 6500K. Replace 57 and 40 with 65 to get 5700K and 4000K respectively

LED is an ever improving and evolving technology. Wipro is committed to bring you the best in LED technology. Data given is representative and can change.

IrisLED GOLD FD | LD 71

Recess mounted LED downlighter with flushed diffuser



APPLICATIONS



SPECIFICATIONS

- High efficiency SMD-LED module
- High transmittivity polycarbonate diffuser white powder coated, pressure die-cast aluminium for superior thermal performance
- Aesthetic white rim molded in engineering plastic
- Specially designed, easy to install mounting clips
- Driver pre-wired up to terminal block

INSTALLATION

- Suitable for Armstrong / CRG / TRAC / USG / Celotex / POP modular ceiling system
- Provision for mounting with the help of specially designed mounting clips
- Suitable for ceiling thickness from 6-19 mm

CONTROL GEAR

- Electronic LED driver

DIMENSION DRAWINGS

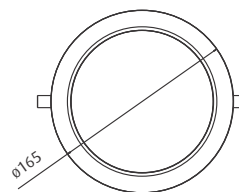
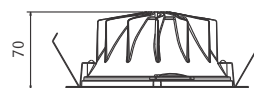

Cutout : 145

All dimensions are in mm. Tolerance ± 2 mm

ELECTRICAL & PACKING DATA

INGRESS PROTECTION **IP20**

| Cat. No.* | Luminaire Lumen OP (Lm) | Nominal System Wattage (W) | Rated Voltage (V) | Mains Current (A) | Case Lot (in nos) |
|--------------------|-------------------------|----------------------------|-------------------|-------------------|-------------------|
| LD71-111-SML-65-FD | 825 | 11 | 240 | 0.17 | 12 |
| LD71-161-SML-65-FD | 1125 | 15 | 240 | 0.35 | 12 |

65 stands for 6500K. Replace 57 and 40 with 65 to get 5700K and 4000K respectively

LED is an ever improving and evolving technology. Wipro is committed to bring you the best in LED technology. Data given is representative and can change.



Halo | CRDL 11

Recess mounted circular LED downlighter



APPLICATIONS



SPECIFICATIONS

- High Luminous Efficacy LEDs
- White powder coated, die cast, LM6 aluminium housing
- Special translucent PMMA diffuser for better light transmission
- High efficient leaf springs in SS202 for ease of recess mounting
- Electronic control gear duly wired up to the terminal block

INSTALLATION

- Provision for mounting with the help of specially designed mounting clips
- Suitable for ceiling thickness from 6-19 mm

DIMENSION DRAWINGS

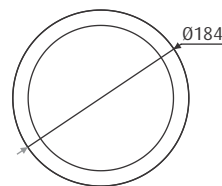
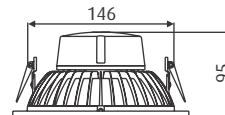

Cutout: Ø172 mm
All dimensions are in mm. Tolerance ± 2 mm

ELECTRICAL & PACKING DATA

INGRESS PROTECTION **IP20**

| Cat. No.* | Luminaire Lumen OP (Lm) | Nominal System Wattage (W) | Rated Voltage (V) | Mains Current (A) | Approx. Weight (kg) | Case Lot (in nos) |
|----------------|-------------------------|----------------------------|-------------------|-------------------|---------------------|-------------------|
| CRDL11R008HP57 | 595 | 6 | 240 | 0.02 | 0.6 | 08 |
| CRDL11R013HP57 | 895 | 9 | 240 | 0.04 | 0.6 | 08 |
| CRDL11R017HP57 | 1195 | 12 | 240 | 0.05 | 0.6 | 08 |
| CRDL11R023HP57 | 1695 | 18 | 240 | 0.08 | 0.6 | 08 |

*Other colour temperatures available on request.

LED is an ever improving and evolving technology. Wipro is committed to bring you the best in LED technology. Data given is representative and can change.



Halo | CRDL 11

Recess mounted circular LED downlighter



APPLICATIONS



SPECIFICATIONS

- Spun housing made of 1.0mm thick aluminium sheet & white powder coated finish
- Die cast heat sink with black powder coating for better aesthetics and functionality
- Special translucent PMMA diffuser for better light transmission
- High luminous flux imported LEDs for better light output
- Easy to mount on Grid/POP and quick to service; High efficient Torsional springs for ease of recess mounting
- Electronic control gear duly wired up to the terminal block
- Fixture is enabled with Analog dimming
- Designed and manufactured to comply with IS 10322 part 5/Sec 1 1987

INSTALLATION

- Suitable for true ceiling/Grid/POP

DIMENSION DRAWINGS

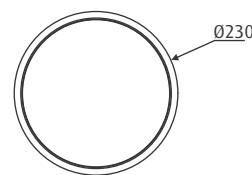
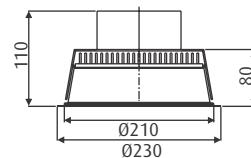

Cutout: Ø220mm
All dimensions are in mm. Tolerance ± 2 mm

ELECTRICAL & PACKING DATA

INGRESS PROTECTION **IP20**

| Cat. No.* | Luminaire Lumen OP (Lm) | Nominal System Wattage (W) | Rated Voltage (V) | Mains Current (A) | Approx. Weight (kg) | Case Lot (in nos) |
|----------------|-------------------------|----------------------------|-------------------|-------------------|---------------------|-------------------|
| CRDL11R033HP57 | 2690 | 26 | 240 | 0.11 | 1.4 | 04 |

*Other colour temperatures available on request.
LED is an ever improving and evolving technology. Wipro is committed to bring you the best in LED technology. Data given is representative and can change.

Halo | CRDL 11

Surface mounted circular LED downlighter



APPLICATIONS



SPECIFICATIONS

- High Luminous Efficacy LEDs
- White powder coated, die cast, LM6 aluminium housing
- Special translucent PMMA diffuser for better light transmission
- High efficient leaf springs in SS202 for ease of recess mounting
- Electronic control gear duly wired up to the terminal block

INSTALLATION

- Cylindrical skirt made of CRCA 0.5mm thick and white powder coated for surface mounting
- Bracket to Mount on true ceiling made of 1.6mm CRCA, zinc blue passivated

DIMENSION DRAWINGS

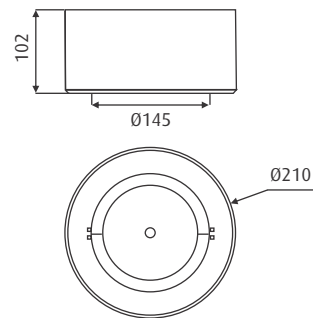

All dimensions are in mm. Tolerance ± 2 mm

ELECTRICAL & PACKING DATA

INGRESS PROTECTION **IP20**

| Cat. No.* | Luminaire Lumen OP (Lm) | Nominal System Wattage (W) | Rated Voltage (V) | Mains Current (A) | Approx. Weight (kg) | Case Lot (in nos) |
|----------------|-------------------------|----------------------------|-------------------|-------------------|---------------------|-------------------|
| CRDL11S008HP57 | 595 | 6 | 240 | 0.02 | 1.2 | 04 |
| CRDL11S013HP57 | 895 | 9 | 240 | 0.04 | 1.2 | 04 |
| CRDL11S017HP57 | 1195 | 12 | 240 | 0.05 | 1.2 | 04 |
| CRDL11S023HP57 | 1695 | 18 | 240 | 0.08 | 1.2 | 04 |

*Other colour temperatures available on request.

LED is an ever improving and evolving technology. Wipro is committed to bring you the best in LED technology. Data given is representative and can change.



Halo | CRDL 11

Surface mounted circular LED downlighter



APPLICATIONS



SPECIFICATIONS

- Spun housing made of 1.0mm thick aluminium sheet & white powder coated finish
- Die cast heat sink with black powder coating for better aesthetics and functionality
- Special translucent PMMA diffuser for better light transmission
- High luminous flux imported LEDs for better light output
- Easy to mount on True ceiling/ Grid/POP and quick to service; High efficient Torsional springs for ease of recess mounting; White powder coated bracket in 2mm Thick CRCA for surface mounting
- Cylindrical skirt made of CRCA 0.5mm thick and white powder coated for surface mounting
- Electronic control gear duly wired up to the terminal block
- Designed and manufactured to comply with IS 10322 part 5/Sec 1 1987

INSTALLATION

- Suitable for surface mounting

DIMENSION DRAWINGS

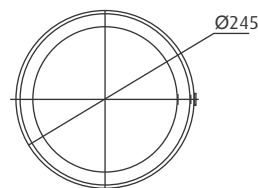
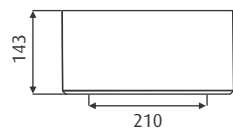

All dimensions are in mm. Tolerance ± 2 mm

ELECTRICAL & PACKING DATA

INGRESS PROTECTION **IP20**

| Cat. No.* | Luminaire Lumen OP (Lm) | Luminaire Wattage (W) | Rated Voltage (V) | Mains Current (A) | Approx. Weight (kg) | Case Lot (in nos) |
|----------------|-------------------------|-----------------------|-------------------|-------------------|---------------------|-------------------|
| CRDL11S033HP57 | 2681 | 26 | 240 | 0.11 | 1.7 | 04 |

*Other colour temperatures available on request.

LED is an ever improving and evolving technology. Wipro is committed to bring you the best in LED technology. Data given is representative and can change.

LED Gimball | LD 56

Circular gimball luminaire



APPLICATIONS



SPECIFICATIONS

- Aluminium die cast construction with white powder coating
- Clear safety glass
- High power high lumen output LED
- High efficiency reflector optics
- Effective thermal management using aluminium casting
- Constant current driver

INSTALLATION

- Provision for mounting with the help of mounting clips with springs for ease of installation and maintainence
- Suitable for mounting in POP, Gypsum board and any other false ceiling



DIMENSION DRAWINGS

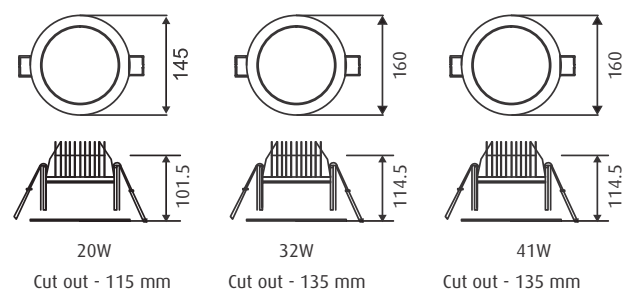

Beam angles: 16°, 24°, 36°, 60°

All dimensions are in mm. Tolerance ± 2 mm

ELECTRICAL & PACKING DATA

INGRESS PROTECTION **IP20**

| Cat. No.* | Luminaire Lumen OP (Lm) | Nominal System Wattage (W) | Rated Voltage (V) | Mains Current (A) | Case Lot (in nos) |
|--------------------|-------------------------|----------------------------|-------------------|-------------------|-------------------|
| LD56-251-060-40-XX | 2080 | 20 | 240 | 0.09 | 12 |
| LD56-381-060-40-XX | 3328 | 32 | 240 | 0.14 | 20 |
| LD56-501-060-40-XX | 4264 | 41 | 240 | 0.18 | 20 |

*Other colour temperatures and beam angles available on request.

LED is an ever improving and evolving technology. Wipro is committed to bring you the best in LED technology. Data given is representative and can change.



LED Tracklight | LD 57

LED Track Light



APPLICATIONS



SPECIFICATIONS

- Aluminium die cast construction with white powder coating
- Clear glass 1mm thick
- High power high lumen output LED
- High efficiency reflector optics
- Effective thermal management using aluminium casting
- Constant current driver
- Integral track adaptor with special track locking system to ensure proper mounting on track

INSTALLATION

- Provision for mounting on track using track adaptor to install and lock the spotlight firmly to the track
- 3 nos. of LD57 can be installed per metre track

DIMENSION DRAWINGS

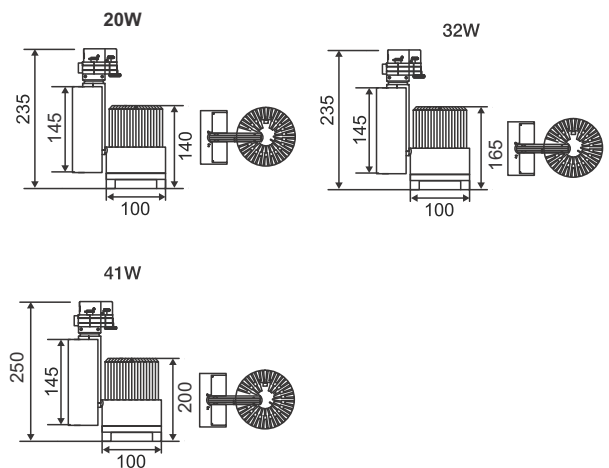

Beam angles - 24°, 36°, 60°

All dimensions are in mm. Tolerance ± 2 mm



ELECTRICAL & PACKING DATA

INGRESS PROTECTION **IP20**

| Cat. No.* | Luminaire Lumen OP (Lm) | Nominal System Wattage (W) | Rated Voltage (V) | Mains Current (A) | Case Lot (in nos) |
|--------------------|-------------------------|----------------------------|-------------------|-------------------|-------------------|
| LD57-251-036-40-XX | 2080 | 20 | 240 | 0.08 | 18 |
| LD57-381-036-40-XX | 3328 | 32 | 240 | 0.14 | 18 |
| LD57-501-036-40-XX | 4264 | 41 | 240 | 0.18 | 12 |

*Other colour temperatures available on request.

LED is an ever improving and evolving technology. Wipro is committed to bring you the best in LED technology. Data given is representative and can change.

LED Gimball | LD 58

Square gimball luminaire



APPLICATIONS



SPECIFICATIONS

- Aluminium die cast construction with white powder coating
- Clear glass 1mm thick
- High power high lumen output LED
- High efficiency reflector optics with choice of beam angles
- Effective thermal management using aluminium casting
- Constant current driver

INSTALLATION

- Provision for mounting with the help of mounting clips with springs for ease of installation and maintenance
- Suitable for mounting in POP, Gyp board and any other false ceiling



DIMENSION DRAWINGS

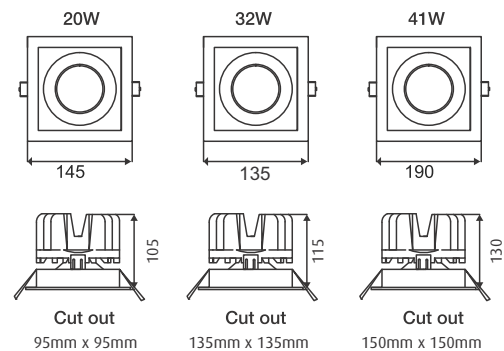

Beam angles - 16°, 24°, 36°, 60°
 All dimensions are in mm. Tolerance ± 2 mm

ELECTRICAL & PACKING DATA

INGRESS PROTECTION **IP20**

| Cat. No.* | Luminaire Lumen OP (Lm) | Nominal System Wattage (W) | Rated Voltage (V) | Mains Current (A) | Case Lot (in nos) |
|--------------------|-------------------------|----------------------------|-------------------|-------------------|-------------------|
| LD58-251-060-40-XX | 2080 | 20 | 240 | 0.08 | 20 |
| LD58-381-060-40-XX | 3328 | 32 | 240 | 0.14 | 20 |
| LD58-501-060-40-XX | 4264 | 41 | 240 | 0.18 | 20 |

*Other colour temperatures available on request. Available in double/triple configurations as well.

LED is an ever improving and evolving technology. Wipro is committed to bring you the best in LED technology. Data given is representative and can change.



LED Swivel Projector | LD 59

Circular adjustable/rotatable downlight luminaire



APPLICATIONS



SPECIFICATIONS

- Aluminium die-cast construction with white powder coating
- Clear Safety Glass
- High power high lumen output COB LED
- High efficiency reflector optics
- Rotatable upto 360° and adjustable upto 45°
- Effective thermal management using aluminium casting

INSTALLATION

- Provision for mounting with the help of mounting clips with springs for ease of installation and maintainence
- Suitable for mounting in POP, Gypsum board and any other false ceiling



DIMENSION DRAWINGS

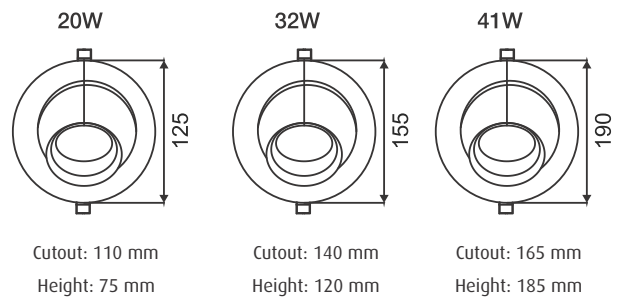

Beam angles - 16°, 24°, 36°, 60°

All dimensions are in mm. Tolerance ± 2 mm

ELECTRICAL & PACKING DATA

INGRESS PROTECTION **IP20**

| Cat. No.* | Luminaire Lumen OP (Lm) | Nominal System Wattage (W) | Rated Voltage (V) | Mains Current (A) | Case Lot (in nos) |
|--------------------|-------------------------|----------------------------|-------------------|-------------------|-------------------|
| LD59-251-036-40-XX | 2080 | 20 | 240 | 0.08 | 20 |
| LD59-381-036-40-XX | 3328 | 32 | 240 | 0.14 | 18 |
| LD59-501-036-40-XX | 4264 | 41 | 240 | 0.18 | 8 |

*Other colour temperatures available on request.

LED is an ever improving and evolving technology. Wipro is committed to bring you the best in LED technology. Data given is representative and can change.

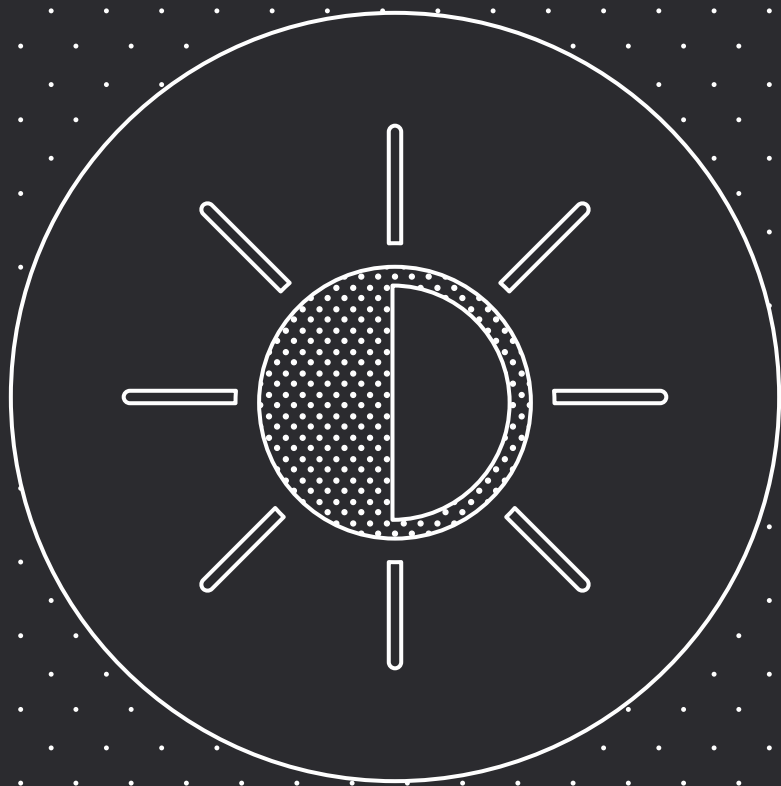



lighting controls

eSavvy | CRPS 10







Smart PIR occupancy sensor



APPLICATIONS



SPECIFICATIONS

-  Advanced passive infrared technology
-  5-7m Detection pattern & range
-  2.8 m Maximum installation height
-  Adjustable off delay timing is 1-90min in predefined steps
-  10A Maximum system load
-  V Supply voltage 230VAC + 10%, 50Hz

DIMENSION DRAWINGS

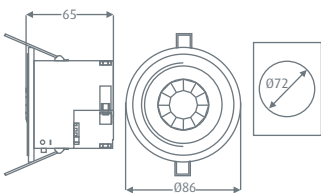

All dimensions are in mm. Tolerance ± 2 mm
Cutout dimension : $\varnothing 72$ mm

AREA DETECTION

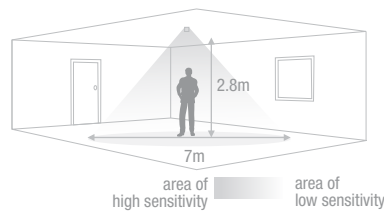

ELECTRICAL & PACKING DATA

INGRESS PROTECTION **IP20**

| Cat. No.* | Sensing Technology | Max. Height | Area of Detection | Off Delay Timing | Lighting Load |
|-------------|--------------------|-------------|-------------------|------------------------------|---------------|
| CRPS10R010A | Passive Infrared | 2.8m | 7m | 1-90 min in predefined steps | 10A |



eSavvy | CRPS 13







PIR Sensor Switching Photocell



APPLICATIONS



SPECIFICATIONS

-  Advanced passive infrared with Switching photocell technology
-  Detection pattern and range
-  2.8 m Maximum installation height
-  Adjustable off delay timing 1-90 min in predefined steps
-  Adjustable lux levels 100-1000 lux
-  10A Maximum system load
-  Supply voltage 230VAC + 10%, 50Hz

DIMENSION DRAWINGS

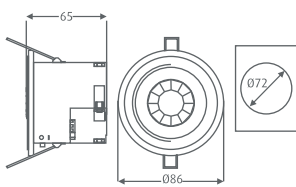

AREA DETECTION

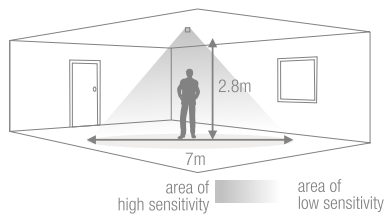

All dimensions are in mm. Tolerance \pm 2mm Cutout dimension : \varnothing 72mm

ELECTRICAL & PACKING DATA

INGRESS PROTECTION **IP20**

| Cat. No.* | Sensing Technology | Max. Height | Area of Detection | Lux Levels | Off Delay Timing | Lighting Load |
|-------------|--------------------|-------------|-------------------|--------------|-----------------------------|---------------|
| CRPS13R010A | Passive Infrared | 2.8m | 7m | 100-1000 lux | 1-90min in predefined steps | 10A |

eSavvy | CRAD

High performance programmable PIR occupancy sensor with day light dimming



APPLICATIONS



SPECIFICATIONS



Advanced passive infrared (PIR) technology



Detection pattern and range



Maximum installation height



Adjustable off delay timing is 1-90 min in pre-defined steps



Adjustable lux levels 100-1000 lux



0-10V DC Analog dimmable control with maximum 25 ballasts



Maximum system load



Supply voltage 230VAC + 10%, 50Hz

DIMENSION DRAWINGS

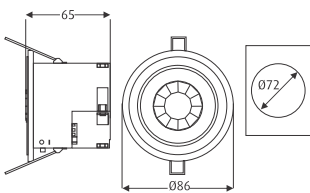

All dimensions are in mm. tolerance + 2mm
Cutout dimension : Ø 72mm

AREA DETECTION

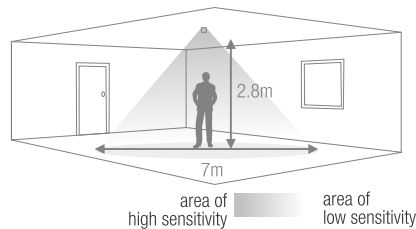

ELECTRICAL & PACKING DATA

INGRESS PROTECTION **IP20**

| Cat. No.* | Sensing Technology | Max. Height | Area of Detection | Lux Level | Off Delay Timing | Lighting Load |
|----------------|--------------------|-------------|-------------------|--------------|-------------------------------|---------------|
| CRADDPS10R010A | Passive Infrared | 2.8m | 7m | 100-1000 lux | 1-90 min in pre-defined steps | 10A |



eSense | COM 20/ CDA 21







High performance microwave occupancy and daylight dimming sensors



APPLICATIONS



SPECIFICATIONS

-  Advanced presence detection by microwave technology
-  Detection pattern and range in metres under normal operating conditions
-  Maximum installation height
-  Adjustable off delay timing 10 sec- 99 min
-  Maximum system load
-  Supply voltage 230VAC + 10%, 50Hz

DIMENSION DRAWINGS

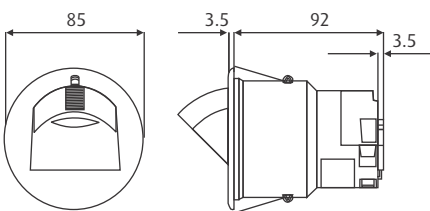

All dimensions are in mm. tolerance ± 2 mm
Cutout dimension : $\varnothing 60$ mm

AREA DETECTION

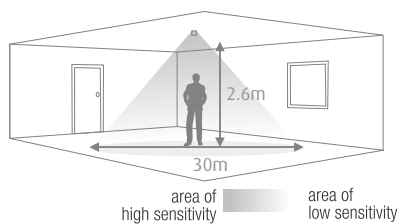

ELECTRICAL & PACKING DATA

INGRESS PROTECTION **IP20**

| Cat. No.* | Sensing Technology | Max. Height | Area of Detection | Lighting Load |
|-----------|--------------------|-------------|-------------------|---------------|
| COM 20010 | Microwave | 2.6m | 30 x 6m | 10A |
| CDA 21010 | Microwave | 2.6m | 30 x 6m | 10 Ballasts |

eSense | COM 23/ CDA 24







High performance programmable PIR occupancy sensor with day light dimming



APPLICATIONS



SPECIFICATIONS

-  Advanced presence detection by microwave technology
-  16 m Detection pattern and range in metres under normal operating conditions
-  2.8 m Maximum installation height
-  Adjustable off delay timing 10 sec- 99 min
-  10A Maximum system load
-  V Supply voltage 230VAC + 10%, 50Hz

DIMENSION DRAWINGS

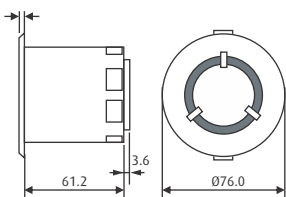

All dimensions are in mm. tolerance + 2mm
Cutout dimension : Ø 60mm

AREA DETECTION

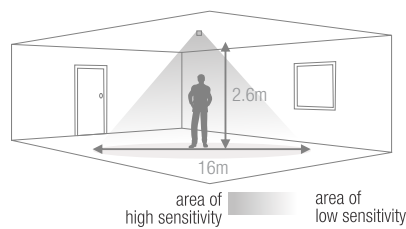

ELECTRICAL & PACKING DATA

INGRESS PROTECTION **IP20**

| Cat. No.* | Sensing Technology | Max. Height | Area of Detection | Lighting Load |
|-----------|--------------------|-------------|-------------------|---------------|
| COM 23010 | Microwave | 2.8m | 16 m | 10A |
| CDA 24010 | Microwave | 2.8m | 16 m | 10 Ballasts |



SCENE SELECT SYSTEM

Set lighting scene to match your moods

eSense architectural dimming systems offer flexibility, convenience and comfort. A smart and stylish dimming module replaces multiple switches and dimmers, typically for applications like conference rooms, auditoriums, board rooms etc

1 Channel Scene Select



2 Channel Scene Select

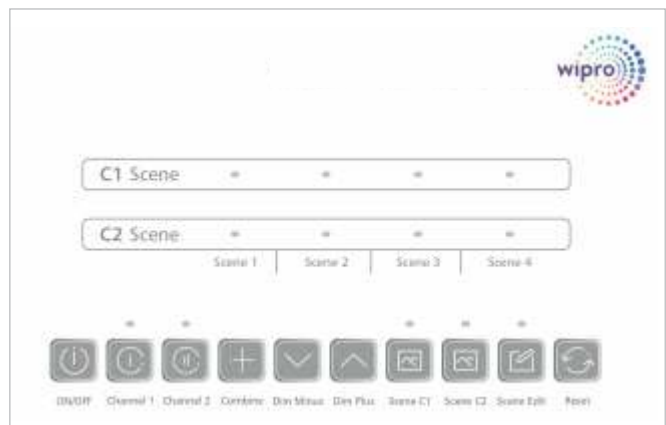

4 Channel Scene Select

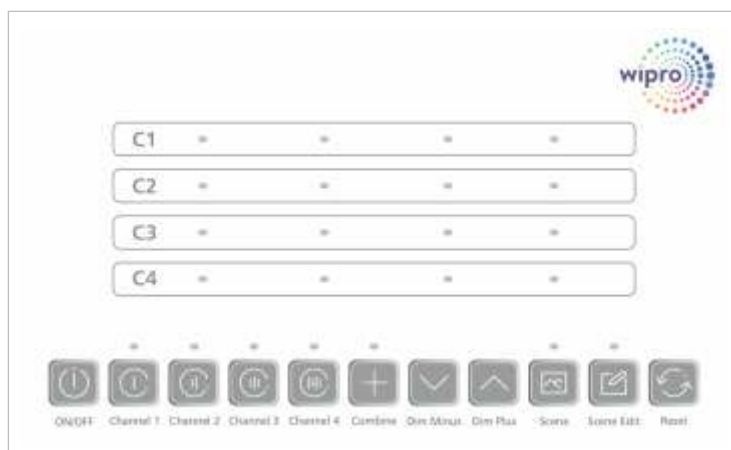



APPLICATIONS



SPECIFICATIONS

1 & 2 Channel Scene Select

- Wall mounted (recessed)
- Inbuilt power module
- Non-volatile memory storage
- Channels of 1-10 V DC for controlling dimmable ballasts/drivers or other loads (Active Control)
- Maximum load - 10A - for 1 Ch
- Maximum load - 20A (Each Channel-10A) - for 2 Ch
- Power up to 2kW - 1 Ch
- Power up to 4kW - 2 Ch
- Signal current sourcing up to 50mA (up to 20 Ballast) - 1 Ch
- Signal current sourcing up to 100mA (up to 50 Ballast- each channel) - 2Ch

4 Channel Scene Select

- Wall Mounted (recessed)
- Inbuilt power module
- Non-volatile memory storage
- Maximum load - 20A (Each Channel - 5A)
- Channels of 1-10V DC for controlling dimmable ballasts/drivers
- Power up to 4kW (Each Channel - 1kW)
- Signal current sourcing up to 100mA (up to 50 Ballast - each channel)

ELECTRICAL & PACKING DATA

INGRESS PROTECTION **IP20**

| Product Code | Input Voltage | Output Load(A) | Output Watt | Signal Sourcing Current (mA) |
|----------------------|---------------|----------------|-------------|------------------------------|
| CRADSS11R010A (1 Ch) | 230V AC | 10A (Max) | 2kW (Max) | upto 50 mA |
| CRADSS12R020A (2 Ch) | 230V AC | 20A (Max) | 4kW (Max) | upto 100 mA |
| CRADSS13R040A (4 Ch) | 230V AC | 20A (Max) | 4kW (Max) | upto 100 mA |

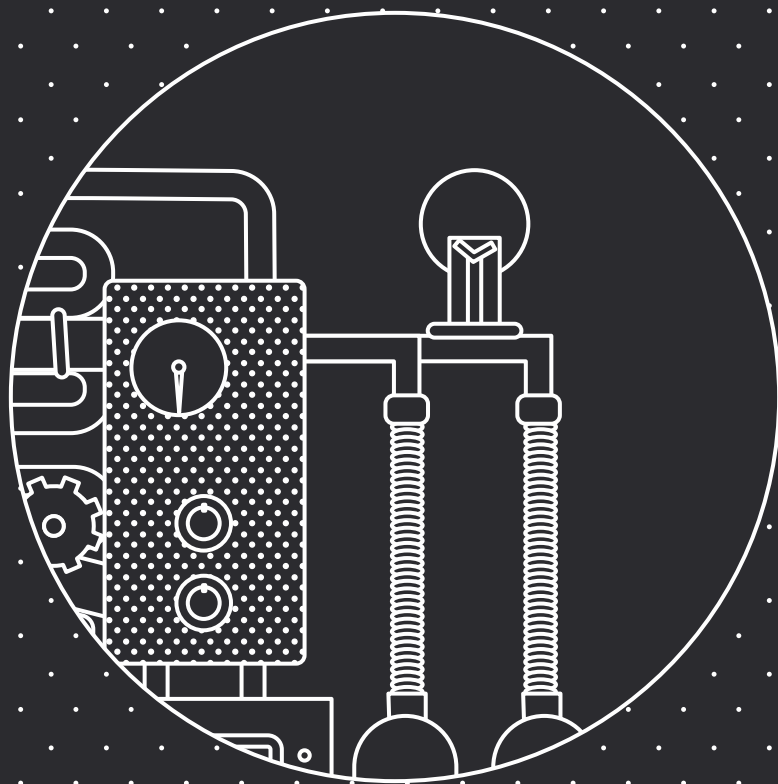



industries

RadialLED Prime | LH 09

Integral SMD LED highbay luminaire with aluminium reflector

APPLICATIONS



FEATURES & BENEFITS

Innovatively designed heat sink

Specially designed aluminium heat sink provides excellent 3D heat dissipation and unique vertical fins avoid dust accumulation.

Polycarbonate high transitivity diffuser

The shatterproof diffuser design, maintains safety and gives uniform and wider light distribution creating an error free work.

High efficacy LEDs

Best-in-class SMD LEDs provide high lumen output, which contributes upto 55% energy savings.

Easy installation and zero maintenance

RadialLED is equipped with factory fitted eye bolt for suspension which makes installation easy.



SPECIFICATIONS

- High efficacy surface mounted (SMD) LEDs
- Specially designed aluminium heat sink
- Polycarbonate high transmittivity diffuser
- Aluminium spun reflector
- Integral product with LED, driver and 3 core wire with 1 sq mm each given out for input power
- IS 10322 part 5/Sec 1 1987 comply

INSTALLATION

- Factory fitted eye bolt for suspension
- The reflector is fixed by rotatory buckle, installed without tools

CONTROL GEAR OPTION

- In-built integrated Electronic LED driver

DIMENSION DRAWINGS

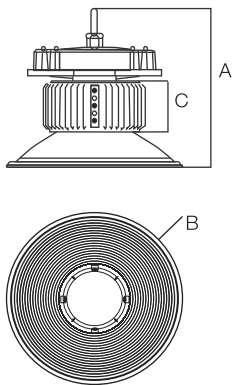

| Product code | Watt(w) | Beam Angle | A(mm) | B(mm) | C(mm) |
|--------------------|---------|------------|-------|-------|-------|
| LH09-102-060-50-G1 | 80 | 60 | 325 | Ø270 | 74 |
| LH09-102-100-50-G1 | | 100 | 293 | Ø360 | 74 |
| LH09-122-060-50-G1 | 100 | 60 | 325 | Ø270 | 74 |
| LH09-122-100-50-G1 | | 100 | 293 | Ø360 | 74 |
| LH09-172-060-50-G1 | 140 | 60 | 354 | Ø270 | 104 |
| LH09-172-100-50-G1 | | 100 | 323 | Ø360 | 104 |
| LH09-232-060-50-G1 | 200 | 60 | 404 | Ø270 | 154 |
| LH09-232-100-50-G1 | | 100 | 373 | Ø360 | 154 |

All dimensions are in mm. Tolerance ± 2 mm

ELECTRICAL & PACKING DATA

INGRESS PROTECTION **IP65**

| Cat. No.* | Luminaire Lumen OP (Lm) | Nominal System Wattage (W) | Rated Voltage (V) | Mains Current (A) | Approx Weight (kg) | Case Lot (in nos) |
|--------------------|-------------------------|----------------------------|-------------------|-------------------|--------------------|-------------------|
| LH09-102-060-50-G1 | 8924 | 80 | 240 | 0.35 | 2.5 | 4 |
| LH09-122-060-50-G1 | 11178 | 100 | 240 | 0.43 | 2.5 | 4 |
| LH09-172-060-50-G1 | 15655 | 140 | 240 | 0.61 | 3.0 | 4 |
| LH09-232-060-50-G1 | 21990 | 200 | 240 | 0.87 | 3.5 | 4 |

60 represents beam angle. For 100 degree beam angle, replace 60 with 100

LED is an ever improving and evolving technology. Wipro is committed to bring you the best in LED technology. Data given is representative and can change.

RadialLED | LH 09

Rugged LED midbay and highbay for varied industrial applications



APPLICATIONS



SPECIFICATIONS

- High efficiency, long life, high power LED
- Black color powder coated aluminium heat sink for efficient heat dissipation
- High purity anodized aluminium reflector with electrochemically anodised matt finish inside
- Highly effective glass optics for maximum illumination
- Constant current LED Driver
- Complete assembly with LED, Driver and accessories pre-wired in driver compartment
- Integral covered control gear compartment

INSTALLATION

- Factory fitted eye bolt for suspension

CONTROL GEAR OPTION

- In-built Electronic LED driver

DIMENSION DRAWINGS

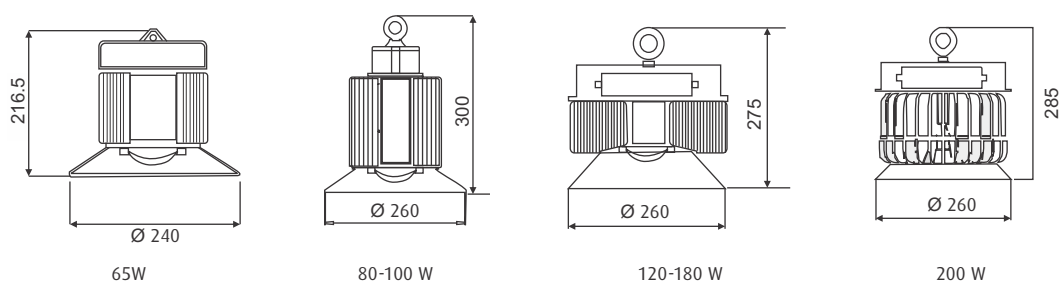

All dimensions are in mm. Tolerance ± 2 mm

ELECTRICAL & PACKING DATA

INGRESS PROTECTION **IP65**

| Cat. No.* | Luminaire Lumen OP (Lm) | Luminaire Wattage (W) | Rated Voltage (V) | Mains Current (A) | Approx. Weight (kg) | Case Lot (in nos) |
|--------------------|-------------------------|-----------------------|-------------------|-------------------|---------------------|-------------------|
| LH09-851-060-50-V5 | 8450 | 65 | 240 | 0.29 | 2.9 | 01 |
| LH09-921-060-50-V5 | 10396 | 80 | 240 | 0.35 | 3.5 | 01 |
| LH09-132-060-50-V5 | 13000 | 100 | 240 | 0.44 | 3.5 | 01 |
| LH09-122-060-50-V5 | 15603 | 120 | 240 | 0.53 | 5.0 | 01 |
| LH09-192-060-50-V5 | 17499 | 135 | 240 | 0.59 | 5.0 | 01 |
| LH09-212-060-50-V5 | 20486 | 165 | 240 | 0.72 | 5.2 | 01 |
| LH09-262-060-50-V5 | 23932 | 200 | 240 | 0.88 | 7.2 | 01 |

60 represents 60 degree beam angle. For 90 degree beam angle, replace 60 by 90.

*Other colour temperatures available on request. LED is an ever improving and evolving technology. Wipro is committed to bring you the best in LED technology. Data given is representative and can change.



LED Highbay | LH 14

High efficiency LED midbay/highbay/undercanopy luminaire



APPLICATIONS



SPECIFICATIONS

- Aluminium die cast housing powder coated
- High efficiency, long life, LEDs
- High purity PMMA lenses for superior performance
- Toughened glass with silicon gaskets for IP66 Protection
- Complete assembly with LED, driver and accessories pre-wired up to terminal block in connector compartment
- Integral control gear compartment with connector

INSTALLATION

- Designed for installation for recess mounting in canopy
- Factory fitted steel eye bolt for suspension

CONTROL GEAR OPTION

- In-built integrated Electronic LED driver



DIMENSION DRAWINGS

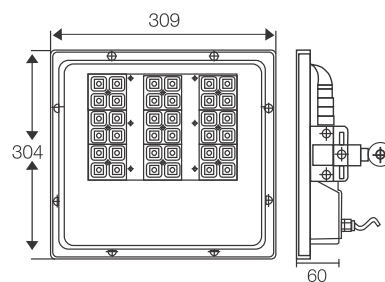

Cutout size 280 x 280 mm +2/-0

All dimensions are in mm. Tolerance ± 2 mm

ELECTRICAL & PACKING DATA

INGRESS PROTECTION **IP66**

| Cat. No. | Luminaire Lumen OP (Lm) | Luminaire Wattage (W) | Rated Voltage (V) | Mains Current (A) | Case Lot (in nos) |
|--------------------|-------------------------|-----------------------|-------------------|-------------------|-------------------|
| LH14-102-XXX-57-XX | 8263 | 80 | 240 | 0.35 | 01 |
| LH14-192-XXX-57-XX | 15000 | 150 | 240 | 0.35 | 01 |

LED is an ever improving and evolving technology. Wipro is committed to bring you the best in LED technology. Data given is representative and can change.

XpressbayLED | LH 15

Linear LED highbay suspended luminaire



APPLICATIONS



SPECIFICATIONS

- Highly advanced LEDs
- Aluminium extruded housing duly powder coated with dark grey pure polyester powder
- Metal clad PCB's
- Technically advanced optic lens with high precision light direction
- Dimming options are available DALI/ANA
- IP 65 driver with high performance
- Designed and manufactured to comply with IS 10322 part 5/Sec 1 1987

INSTALLATION

- Flexible suspension system
- Suitable for suspended and surface mounting arrangement
- Loop in loop out connection is provided in the fixture

DIMENSION DRAWINGS

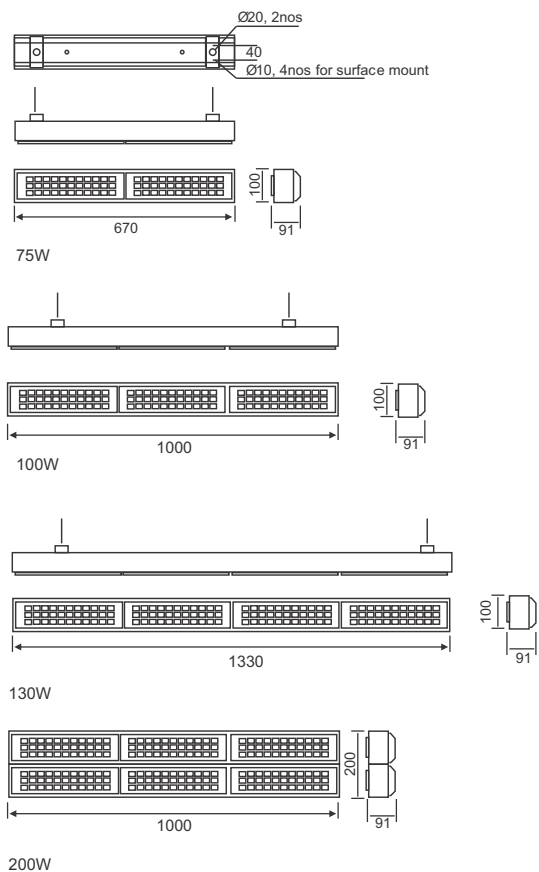

All dimensions are in mm. Tolerance ± 2 mm

ELECTRICAL & PACKING DATA

INGRESS PROTECTION **IP65**

| Cat. No.* | Luminaire Lumen OP (Lm) | Luminaire Wattage (W) | Rated Voltage (V) | Mains Current (A) | Approx. Weight (kg) | Case Lot (in nos) |
|--------------------|-------------------------|-----------------------|-------------------|-------------------|---------------------|-------------------|
| LH15-102-060-57-XX | 9375 | 75 | 240 | 0.32 | 3 | 2 |
| LH15-142-060-57-XX | 12500 | 100 | 240 | 0.43 | 4 | 2 |
| LH15-182-060-57-XX | 16250 | 130 | 240 | 0.57 | 5 | 2 |
| LH15-282-060-57-XX | 25000 | 200 | 240 | 0.87 | 7 | 1 |

60 represents beam angle. Replace 60 with 90 for 90 degree beam angle.

LED is an ever improving and evolving technology. Wipro is committed to bring you the best in LED technology. Data given is representative and can change.



WellglassLED | LE 02

LED wellglass luminaire



APPLICATIONS

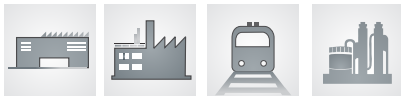

SPECIFICATIONS

- Pressure die-cast aluminium construction with powder coated finish
- High power, high efficiency LED
- Thermally isolated driver and optical compartment
- Injection molded translucent white impact resistant polycarbonate diffuser
- Long life and heat resistant gaskets
- Accessories pre-wired up to terminal block

INSTALLATION

- Suitable for ceiling mounted

CONTROL GEAR OPTION

- Inbuilt integrated Electronic LED Driver

DIMENSION DRAWINGS

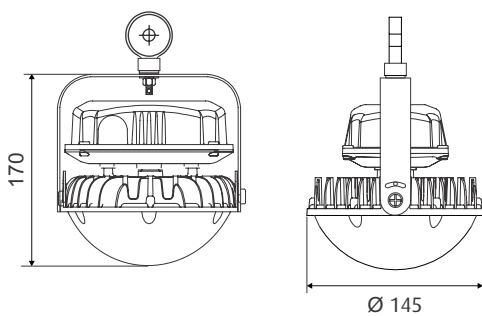

All dimensions are in mm. Tolerance ± 2 mm

ELECTRICAL & PACKING DATA

INGRESS PROTECTION **IP66**

| Cat. No.* | Luminaire Lumen OP (Lm) | Luminaire Wattage (W) | Rated Voltage (V) | Mains Current (A) | Case Lot (in nos) |
|--------------------|-------------------------|-----------------------|-------------------|-------------------|-------------------|
| LE02-441-XXX-57-OP | 3430 | 35 | 240 | 0.16 | 08 |

Also available with clear diffuser, glass and glass mesh (on request)

LED is an ever improving and evolving technology. Wipro is committed to bring you the best in LED technology. Data given is representative and can change.

WellglassLED | LE 02

LED wellglass luminaire



APPLICATIONS



SPECIFICATIONS

- Pressure die-cast aluminium construction with powder coated finish
- High power, high efficiency LED
- Thermally isolated driver and optical compartment
- Injection molded translucent white impact resistant polycarbonate diffuser
- Long life and heat resistant gaskets
- Accessories pre-wired up to terminal block

INSTALLATION

- Suitable for pendant mounted using eye bolt

CONTROL GEAR OPTION

- Inbuilt integrated Electronic LED Driver

DIMENSION DRAWINGS

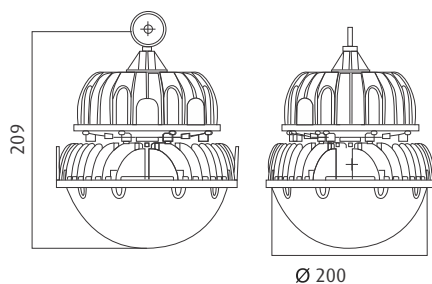

All dimensions are in mm. Tolerance ± 2 mm

ELECTRICAL & PACKING DATA

INGRESS PROTECTION **IP66**

| Cat. No.* | Luminaire Lumen OP (Lm) | Luminaire Wattage (W) | Rated Voltage (V) | Mains Current (A) | Case Lot (in nos) |
|--------------------|-------------------------|-----------------------|-------------------|-------------------|-------------------|
| LE02-821-XXX-57-OP | 6860 | 70 | 240 | 0.36 | 04 |

Also available with clear diffuser, glass and glass mesh (on request)

LED is an ever improving and evolving technology. Wipro is committed to bring you the best in LED technology. Data given is representative and can change.



StormLED | LE 02

IP 65 high efficiency LED wellglass



APPLICATIONS



SPECIFICATIONS

- Rugged & light weight pressure die cast aluminium construction with black powder coating
- Integral radial fins for better heat dissipation
- High power, high efficiency LED
- White powder coated internal reflector
- Thermally isolated driver and optical compartment
- Injection molded translucent white impact resistant polycarbonate diffuser
- Long life and heat resistant Silicon and EPDM rubber gaskets
- IP66 Cable glands

INSTALLATION

- Suitable for cradle mounted
- Also suitable for ceiling mounting

ACCESSORIES

- Cable gland PG11, suitable for power cable outer diameter up to 8.0 mm. 3 core wire, 1 sq. mm of each is given out through cable gland for input powers
- Adjustable mounting bracket

CONTROL GEAR OPTION

- Energy efficient electronic LED driver



DIMENSION DRAWINGS

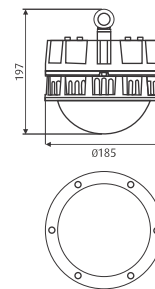

All dimensions are in mm. Tolerance ± 2 mm

ELECTRICAL & PACKING DATA

INGRESS PROTECTION **IP66**

| Cat. No.* | Luminaire Lumen OP (Lm) | Luminaire Wattage (W) | Rated Voltage (V) | Mains Current (A) | Approx. Weight (kg) | Case Lot (in nos) |
|--------------------|-------------------------|-----------------------|-------------------|-------------------|---------------------|-------------------|
| LE02-391-XXX-65-XX | 2701 | 29 | 240 | 0.13 | 2.1 | 04 |
| LE02-521-XXX-65-XX | 3702 | 40 | 240 | 0.18 | 2.1 | 04 |

*Other colour temperatures available on request. LED is an ever improving and evolving technology. Wipro is committed to bring you the best in LED technology. Data given is representative and can change.

CapsuleLED | LE 20

Surface/pendant mounted totally enclosed LED luminaire



APPLICATIONS



SPECIFICATIONS

- Totally enclosed LED luminaire with high luminous efficacy
- LEDs and energy efficient driver
- Sturdy vandal resistant light grey polycarbonate body with polyurethane gasket
- LED grade UV stabilize polycarbonate diffuser
- Sturdy polycarbonate clips for fixing diffuser to housing
- Waterproof cable gland ensures good ingress protection

INSTALLATION

- Stainless steel mounting clips are provided for easy and quick installation

ACCESSORIES

- Energy efficient LED driver
- 3-way 10 Amp GFP mains connector for 1 sq mm incoming cable
- All accessories are pre-wired upto terminal block

DIMENSION DRAWINGS

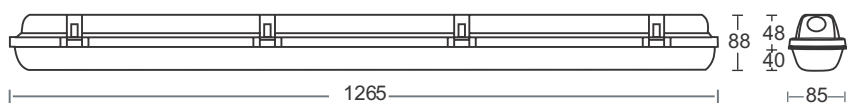

All dimensions are in mm. Tolerance ± 2 mm

ELECTRICAL & PACKING DATA

INGRESS PROTECTION **IP65**

| Cat. No.* | Luminaire Lumen OP (Lm) | Luminaire Wattage (W) | Rated Voltage (V) | Mains Current (A) | Approx. Weight (kg) |
|--------------------|-------------------------|-----------------------|-------------------|-------------------|---------------------|
| LE20-491-XXX-57-XX | 4156 | 39 | 240 | 0.18 | 1.7 |

LED is an ever improving and evolving technology. Wipro is committed to bring you the best in LED technology. Data given is representative and can change.



XlineLED Pro | LE 14

Trunk mounted LED channel



APPLICATIONS



SPECIFICATIONS

- High efficacy LEDs
- Specially design extruded aluminium product and trunk
- Polycarbonate high transmittivity extruded diffuser
- Integral product with LED, driver and accessories pre-wired in driver compartment
- Snap on product fitted with trunking
- End to end connectivity
- IS 10322 part 5/Sec 1 1987 comply

INSTALLATION

- Suitable for mounting with aluminium trunk through 12mm threaded rod or 12mm conduit
- Trunking ordering reference LE14A02C, this includes wiring, trunk cover, and mounting clamp suitable for 12mm threaded rod/12 mm conduit

CONTROL GEAR OPTION

- Energy efficient electronic LED driver

DIMENSION DRAWINGS

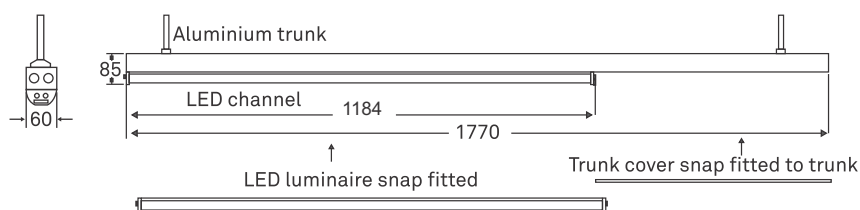

All dimensions are in mm. Tolerance ± 2 mm

ELECTRICAL & PACKING DATA

INGRESS PROTECTION **IP54**

| Cat. No.* | Luminaire Lumen OP (Lm) | Luminaire Wattage (W) | Rated Voltage (V) | Mains Current (A) | Approx. Weight (kg) including trunk | Case Lot (in nos) |
|--------------------|-------------------------|-----------------------|-------------------|-------------------|-------------------------------------|-------------------|
| LE14-491-XXX-57-XX | 4000 | 39 | 240 | 0.17 | 4 | 06 |

LED is an ever improving and evolving technology. Wipro is committed to bring you the best in LED technology. Data given is representative and can change.

XlineLED | LE 10

Industrial integral LED channel



APPLICATIONS



SPECIFICATIONS

- Industrial channel with high luminous efficacy LEDs and energy efficient driver
- Ultra slim, lightweight design with highly effective extruded Polycarbonate diffuser for maximum effective illumination
- Dynamically stylized injection molded plastic end caps

INSTALLATION

- Individual two point surface mounting on ceiling/wall
- Suitable for Wire suspension
- Conduit mounting suitable for 19 mm OD rigid conduit pipe on two knock outs provided on channel

ACCESSORIES

- 3-way 5 amp GFP mains connector for 1.5 sq mm incoming cable
- PVC cable entry grommet suitable for power cable outer diameter up to 6.0mm
- Extruded aluminium trunk LE 14 A02C (1.2 mtr) to be ordered separately

DIMENSION DRAWINGS

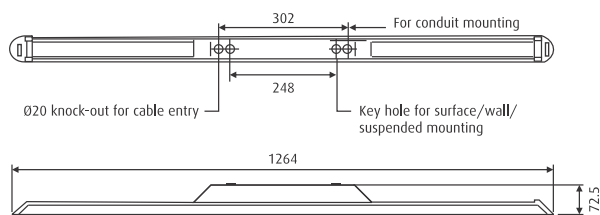

All dimensions are in mm. Tolerance ± 2 mm

CONTROL GEAR OPTION

- Energy efficient LED driver

ELECTRICAL & PACKING DATA

INGRESS PROTECTION **IP20**

| Cat. No.* | Luminaire Lumen OP (Lm) | Luminaire Wattage (W) | Rated Voltage (V) | Mains Current (A) | Approx. Weight (kg) | Case Lot (in nos) |
|--------------------|-------------------------|-----------------------|-------------------|-------------------|---------------------|-------------------|
| LE10-491XXX-57HCSL | 4137 | 39 | 240 | 0.17 | 1.6 | 09 |

*Other colour temperatures available on request.

LED is an ever improving and evolving technology. Wipro is committed to bring you the best in LED technology. Data given is representative and can change.



XlineLED | LE 11

LED channel for retail lighting



APPLICATIONS



SPECIFICATIONS

- Trunking system for modern retail spaces having LEDs with high luminous efficacy and energy efficient driver
- Ultra slim, lightweight design in high quality optics and powder coated CRCA steel
- Minimalistically stylized injection molded plastic end caps
- Diffuser in extruded LED grade Opal Polycarbonate
- Easy installation in trunks with specially designed snap fit stainless steel clips

INSTALLATION

- Suitable for mounting with CRCA as well as with extruded aluminium trunks

ACCESSORIES

- 3-way 5 amp GFP mains connector for 1 sq mm incoming cable
- Extruded aluminium trunk WCX 21770 (1.77 mtr) and WCX 23540 (3.5 mtr) to be ordered separately

DIMENSION DRAWINGS

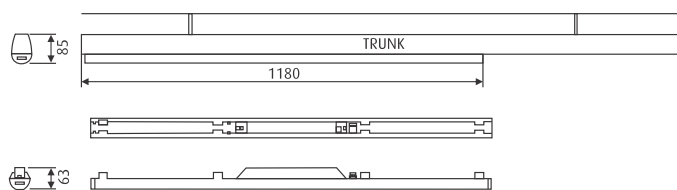

LE 11

All dimensions are in mm. Tolerance ± 2 mm

CONTROL GEAR OPTION

- Energy efficient LED driver

ELECTRICAL & PACKING DATA

INGRESS PROTECTION **IP20**

| Cat. No.* | Luminaire Lumen OP (Lm) | Luminaire Wattage (W) | Rated Voltage (V) | Mains Current (A) | Approx. Weight (kg) | Case Lot (in nos) |
|--------------------|-------------------------|-----------------------|-------------------|-------------------|---------------------|-------------------|
| LE11-491-XXX-57-XX | 4137 | 39 | 240 | 0.17 | 1.2 | 08 |

*Other colour temperatures available on request.

LED is an ever improving and evolving technology. Wipro is committed to bring you the best in LED technology. Data given is representative and can change.

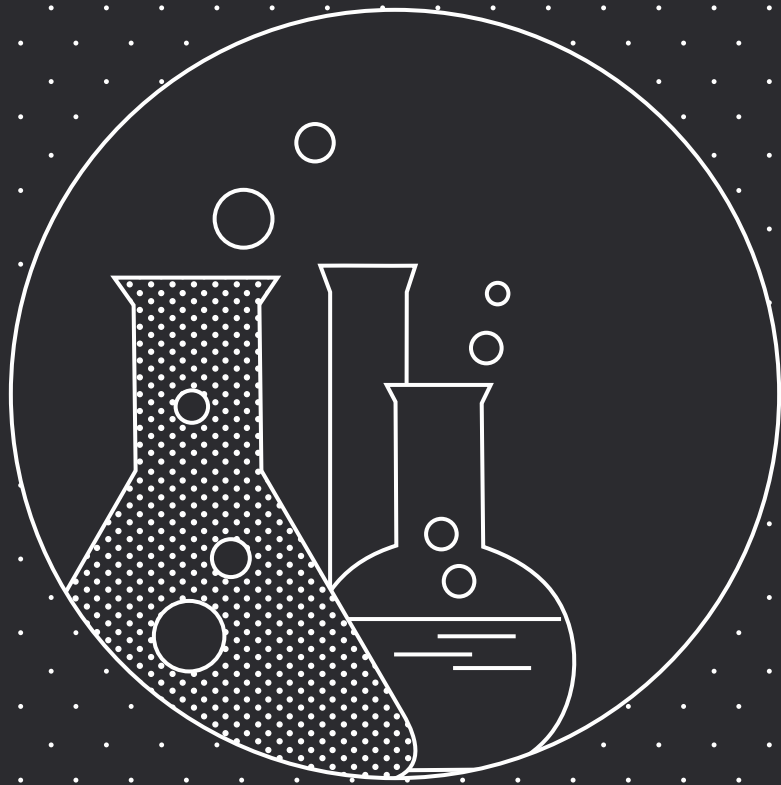



cleanroom

VisonLED Prime TOCR | LC 30

Best-in-class top opening cleanroom luminaire

APPLICATIONS

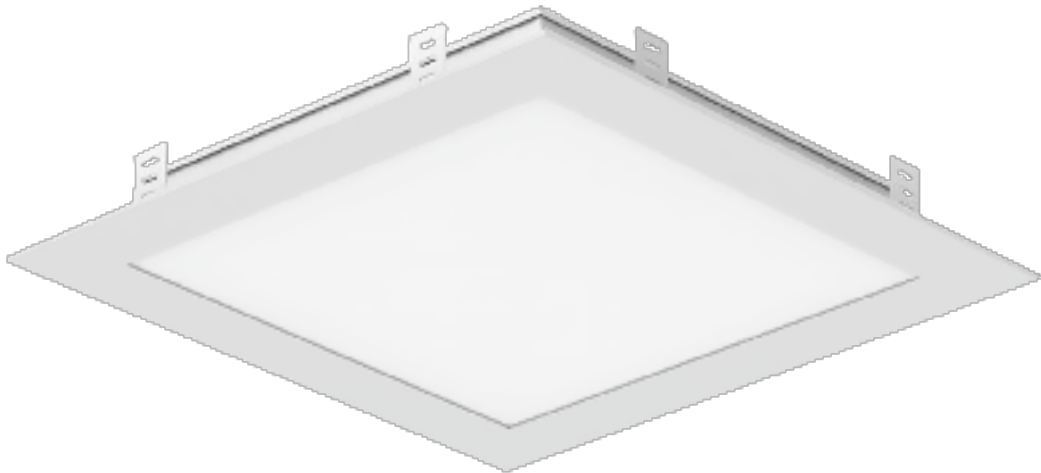

FEATURES & BENEFITS

High Efficacy LEDs

Best-in-class LEDs save energy upto 55% and reduces operational costs.

Self-aligning mounting mechanism

Ensuring precise and faster installation.

Specially designed pressure plates

Designed to ensure positive locking, dust & water proofing.

Height adjusting bracket

Adjustable bracket suitable for 40 to 100mm ceiling thickness.



SPECIFICATIONS

- Luminaire consists of CRCA bottom frame, housing cover, control gear compartment duly epoxy polyester white powder coated
- Satin finish High Efficiency Translucence (HET) diffuser is sealed with bottom frame using
- XLPE gasket and specially designed pressure plates ensures positive locking
- Mounting system using specially designed knob with thrust pad
- High efficacy LEDs
- Electronic LED driver mounted on removable gear tray and pre-wired upto terminal block
- IP65 from front after installation

INSTALLATION

- Designed for installation in RCC slab/metallic walkable sandwich panel ceiling with through & through cut

Top frame with top cover will be offered as accessories

DIMENSION DRAWINGS

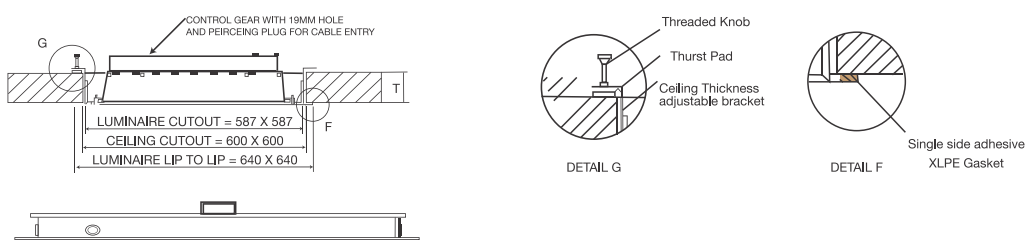

All dimensions are in mm. Tolerance ± 2 mm

Ceiling Cutout TFTC : 600 mm x 600 mm

ELECTRICAL & PACKING DATA

INGRESS PROTECTION **IP65**

From front after installation

| Cat. No.* | Luminaire Lumen OP (Lm) | Luminaire Wattage (W) | Rated Voltage (V) | Mains Current (A) | Case Lot (in nos) |
|--------------------|-------------------------|-----------------------|-------------------|-------------------|-------------------|
| LC30-411-XXX-57-G1 | 2750 | 30 | 240 | 0.13 | 01 |
| LC30-551-XXX-57-G1 | 4087 | 42 | 240 | 0.18 | 01 |
| LC30-721-XXX-57-G1 | 5380 | 60 | 240 | 0.26 | 01 |
| LC30-102-XXX-57-G1 | 7253 | 78 | 240 | 0.34 | 01 |

*Other colour temperatures available on request.

LED is an ever improving and evolving technology. Wipro is committed to bring you the best in LED technology. Data given is representative and can change.

VisionLED BOCR | LC 20

Recess mounted, bottom opening cleanroom LED luminaire



APPLICATIONS



SPECIFICATIONS

- CRCA powder coated housing, bottom frame and reflector
- Surface finish in epoxy polyester powder coating lends higher corrosion resistance & life long finish
- Option of Satin finish High Efficiency Translucence (HET) diffuser/clear acrylic diffuser sealed with bottom frame using non-hygroscopic VHB gasket to ensure dust proofing
- Bottom frame fixed to the housing with captive (loss proof) screws
- Wishbone mechanism for perfect bottom frame alignment and hinging
- Excellent heat dissipation through special design of high thermal conductivity Metal Clad PCB & housing
- High lumen output white LEDs (efficacy of 100 lumens/watt)
- 3 Stage isolated Constant Current Constant Voltage driver (CCCV) with operating voltage range of 150-270VAC
- Driver pre-wired upto terminal block
- Suitable for class 10,000 & 100,000 cleanroom applications
- Conforms to IS10322/Part 5/Sec.1:1987

INSTALLATION

- Ceiling cutout required: 487mm x 487mm
- Ceiling suspension using 19mm OD conduit pipe using knock-outs provided on the housing

ACCESSORIES

- Loop-in, loop-out facility to save cost of cables and switches
- Suitable for 19 mm ET cable entry

DIMENSION DRAWINGS

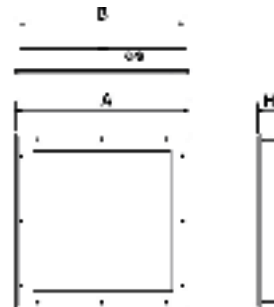

| Cat No. | A | B | H | Cutout |
|--------------------|-----|-----|----|-----------|
| LC20-411-XXX-57-XX | 505 | 485 | 75 | 490 x 490 |
| LC20-551-XXX-57-XX | 595 | 575 | 75 | 580 x 580 |
| LC20-721-XXX-57-XX | 595 | 575 | 75 | 580 x 580 |

All dimensions are in mm. Tolerance ± 2 mm

ELECTRICAL & PACKING DATA

INGRESS PROTECTION **IP54**

From front after installation

| Cat. No.* | Luminaire Lumen OP (Lm) | Nominal System Wattage (W) | Rated Voltage (V) | Mains Current (A) | Case Lot (in nos) |
|--------------------|-------------------------|----------------------------|-------------------|-------------------|-------------------|
| LC20-411-XXX-57-XX | 2860 | 30 | 240 | 0.13 | 02 |
| LC20-551-XXX-57-XX | 4087 | 42 | 240 | 0.18 | 02 |
| LC20-721-XXX-57-XX | 5380 | 60 | 240 | 0.26 | 02 |

LED is an ever improving and evolving technology. Wipro is committed to bring you the best in LED technology. Data given is representative and can change.



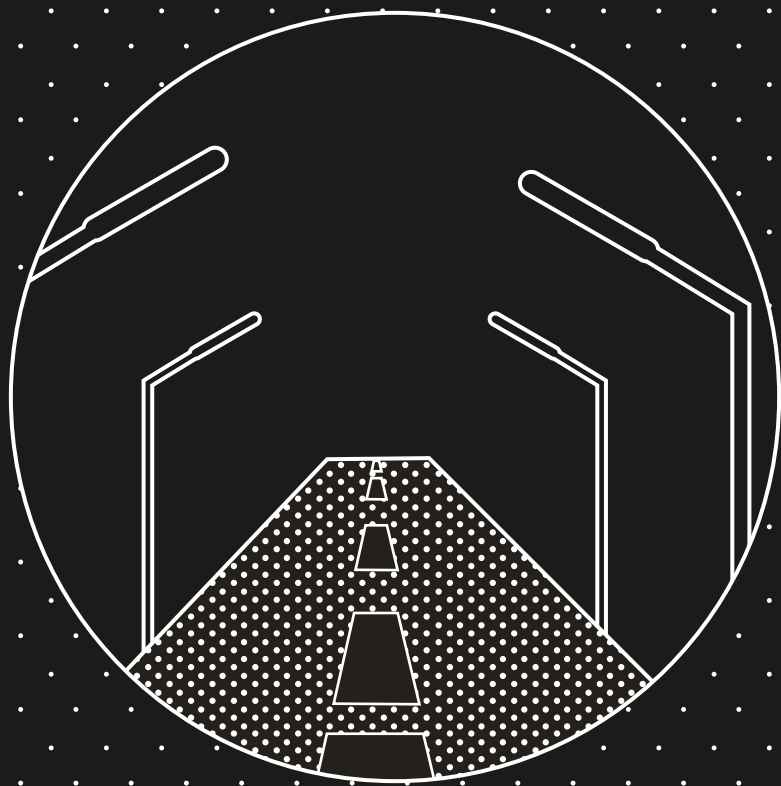



street and flood

skylineLED | LR 02

High performance IP 66 LED streetlight suitable for secondary roads



APPLICATIONS



SPECIFICATIONS

- Aluminium pressure die-cast housing for long life
- High efficiency, long life LEDs
- High purity PC fresnel diffuser with silicon gaskets
- Complete assembly with LEDs, driver and accessories pre-wired up to terminal block
- Conforms to IS10322 Part 5/Sec 1

INSTALLATION

- Suitable for external pole dia. up to 35mm

CONTROL GEAR

- In built integrated electronic LED driver

DIMENSION DRAWINGS

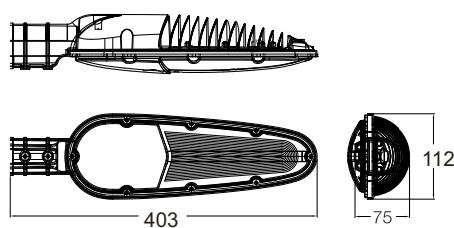

All dimensions are in mm. Tolerance ± 2 mm

* SP for SPD

ELECTRICAL & PACKING DATA

INGRESS PROTECTION **IP65**

| Cat. No.* | Luminaire Lumen OP (Lm) | Nominal System Wattage (W) | Rated Voltage (V) | Mains Current (A) | Case Lot (in nos) |
|--------------------|-------------------------|----------------------------|-------------------|-------------------|-------------------|
| LR02-291-XXX-57-XX | 2500 | 25 | 240 | 0.11 | 08 |
| LR02-331-XXX-57-XX | 3000 | 30 | 240 | 0.13 | 08 |

LED is an ever improving and evolving technology. Wipro is committed to bring you the best in LED technology. Data given is representative and can change.



skylineLED | LR 02

Pressure die-cast IP 66 streetlight



APPLICATIONS



SPECIFICATIONS

- Aluminium pressure die-cast housing for long life
- Pure polyester powder coated dark gray housing
- High efficiency, long life LEDs
- High purity PMMA lenses for superior performance
- Toughened glass with silicon gaskets for IP66 protection
- Complete assembly with LEDs, driver and accessories pre-wired up to terminal block
- Driver cover designed to suit top maintenance
- Conforms to IS10322 Part 5 / Sect 1:1967

INSTALLATION

- Suitable for external pole dia. up to 55mm
- 3 way 10 Amp connector provided for quick connections

CONTROL GEAR

- In built integrated electronic LED driver

DIMENSION DRAWINGS

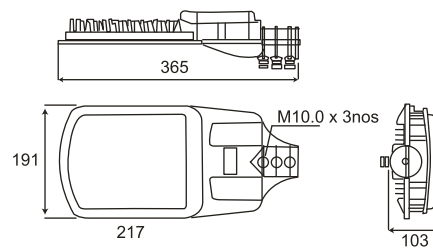

All dimensions are in mm. Tolerance ± 2 mm

ELECTRICAL & PACKING DATA

INGRESS PROTECTION **IP66**

| Cat. No.* | Luminaire Lumen OP (Lm) | Nominal System Wattage (W) | Rated Voltage (V) | Mains Current (A) | Case Lot (in nos) |
|--------------------|-------------------------|----------------------------|-------------------|-------------------|-------------------|
| LR02-391-XXX-57-XX | 3500 | 35 | 240 | 0.15 | 02 |
| LR02-451-XXX-57-XX | 4000 | 40 | 240 | 0.18 | 02 |
| LR02-501-XXX-57-XX | 4500 | 45* | 240 | 0.20 | 02 |

*45 W- IP 66

LED is an ever improving and evolving technology. Wipro is committed to bring you the best in LED technology. Data given is representative and can change.

skylineLED | LR 02

Pressure die-cast IP 66 streetlight



APPLICATIONS



SPECIFICATIONS

- Aluminium pressure die-cast housing for long life
- Pure polyester powder coated dark gray housing
- High efficiency, long life LEDs
- High purity PMMA lenses for superior performance
- Toughened glass with silicon gaskets for IP66 protection
- Complete assembly with LEDs, driver and accessories pre-wired up to terminal block
- Driver cover designed to suit top maintenance
- Conforms to IS10322 Part 5 / Sect 1:1967

INSTALLATION

- Suitable for external pole dia. up to 55mm (60W, 70W, 80W, 90W, 100W)
- Suitable for external pole dia. up to 60mm (110W & 120W)
- 3 Way 10 Amp connector provided for quick connections with cable gland in place with extended wire 150-200 mm out of luminaire

CONTROL GEAR

- In built integrated electronic LED driver

DIMENSION DRAWINGS

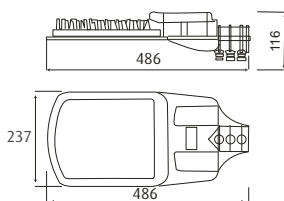

60W, 70W, 80W, 90W & 100W

pipe dia suitable for upto 55mm

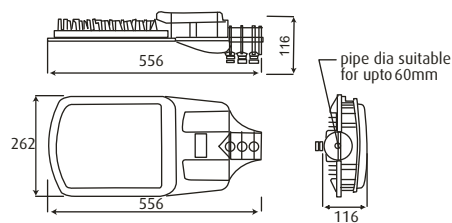

110W & 120W

pipe dia suitable for upto 60mm

All dimensions are in mm. Tolerance ± 2 mm

ELECTRICAL & PACKING DATA

INGRESS PROTECTION **IP66**

| Cat. No.* | Luminaire Lumen OP (Lm) | Nominal System Wattage (W) | Rated Voltage (V) | Mains Current (A) | Case Lot (in nos) |
|--------------------|-------------------------|----------------------------|-------------------|-------------------|-------------------|
| LR02-671-XXX-57-G2 | 6600 | 60 | 240 | 0.26 | 01 |
| LR02-781-XXX-57-G2 | 7700 | 70 | 240 | 0.31 | 01 |
| LR02-981-XXX-57-G2 | 8800 | 80 | 240 | 0.35 | 01 |
| LR02-102-XXX-57-G2 | 9900 | 90 | 240 | 0.39 | 01 |
| LR02-112-XXX-57-G2 | 11000 | 100 | 240 | 0.44 | 01 |
| LR02-122-XXX-57-G2 | 12100 | 110 | 240 | 0.48 | 01 |
| LR02-132-XXX-57-G2 | 13200 | 120 | 240 | 0.53 | 01 |

LED is an ever improving and evolving technology. Wipro is committed to bring you the best in LED technology. Data given is representative and can change.



skylineLED | LR 02

High performance IP 66 LED streetlight suitable for secondary roads



APPLICATIONS



SPECIFICATIONS

- Aluminium pressure Die cast housing parts for long life
- Pure polyester powder coated Dark Gray housing
- High efficiency, long life LEDs
- High purity PMMA lenses for superior performance
- Toughened glass with silicon gaskets for IP66 protection
- Complete assembly with LED, Driver and accessories pre-wired up to terminal block
- Driver cover designed to suit top maintenance
- Conforms to IS10322 Part 5 / Sect 1: 1967

INSTALLATION

- Suitable for external pole dia. Up to 60 mm
- 3 Way 10 Amp connector provided for quick connections with cable gland in place with extended Wire 300 mm out of luminaire

CONTROL GEAR

- In built integrated electronic LED driver

DIMENSION DRAWINGS

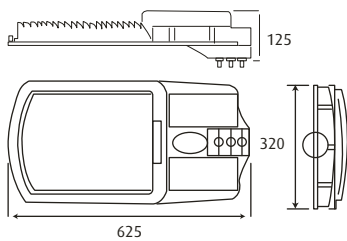

150W, 180W, 200W & 220W

All dimensions are in mm. Tolerance ± 2 mm

* SP for SPD

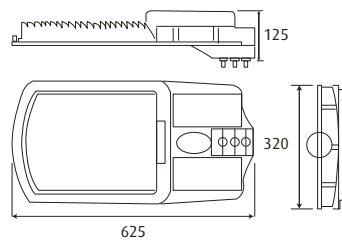

200W, 220W & 250W

All dimensions are in mm. Tolerance ± 2 mm

ELECTRICAL & PACKING DATA

INGRESS PROTECTION **IP66**

| Cat. No.* | Luminaire Lumen OP (Lm) | Nominal System Wattage (W) | Rated Voltage (V) | Mains Current (A) | Case Lot (in nos) |
|--------------------|-------------------------|----------------------------|-------------------|-------------------|-------------------|
| LR02-182-XXX-57-G2 | 16500 | 150 | 240 | 0.66 | 01 |
| LR02-212-XXX-57-G2 | 19800 | 180 | 240 | 0.79 | 01 |
| LR02-242-XXX-57-G2 | 22000 | 200 | 240 | 0.88 | 01 |
| LR02-262-XXX-57-G2 | 24200 | 220 | 240 | 0.96 | 01 |
| LR02-292-XXX-57-G2 | 27500 | 250 | 240 | 1.09 | 01 |





AlphaLED Floodlight | LF 19

Integral cradle mounted high performance LED floodlight



APPLICATIONS



SPECIFICATIONS

- Aluminium die cast housing and frame with powder coating
- High efficiency, long life, LEDs
- 4 x 1 Diffused reflector with 60° Beam made of optical grade polycarbonate for super performance
- Toughened glass with silicon gaskets for IP66 Protection
- Complete assembly with LED, Driver and accessories pre-wired up to terminal block in connector compartment with PG7 cable gland
- Integral control gear compartment with connector

INSTALLATION

- External cradle adjustable mounting arrangement suitable for mounting with 2 Nos. M8 /5/16' bolts.

CONTROL GEAR

- In built integrated electronic LED driver

DIMENSION DRAWINGS

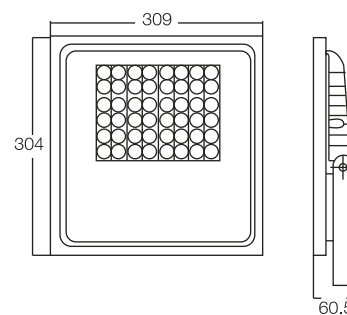

All dimensions are in mm. Tolerance ± 2 mm

ELECTRICAL & PACKING DATA

INGRESS PROTECTION **IP66**

| Cat. No.* | Luminaire Lumen OP (Lm) | Nominal System Wattage (W) | Rated Voltage (V) | Mains Current (A) | Case Lot (in nos) |
|--------------------|-------------------------|----------------------------|-------------------|-------------------|-------------------|
| LF19-711-060-57-XX | 6038 | 60 | 240 | 0.26 | 01 |
| LF19-931-060-57-XX | 8000 | 80 | 240 | 0.37 | 01 |

LED is an ever improving and evolving technology. Wipro is committed to bring you the best in LED technology. Data given is representative and can change.

AlphaLED Floodlight | LF 20

LED floodlight luminaire



APPLICATIONS



SPECIFICATIONS

- Aluminium die-cast housing, powder coated
- High efficiency, long life, LEDs
- High purity polycarbonate lenses for superior performance
- Toughened glass with silicon gaskets for IP66 protection
- Complete assembly with LED, Driver and accessories pre-wired up to terminal block in connector compartment
- Integral control gear compartment with connector

INSTALLATION

- External cradle adjustable mounting arrangement suitable for mounting with 2 Nos.M8/5/16' bolts

CONTROL GEAR

- In built integrated electronic LED driver

DIMENSION DRAWINGS

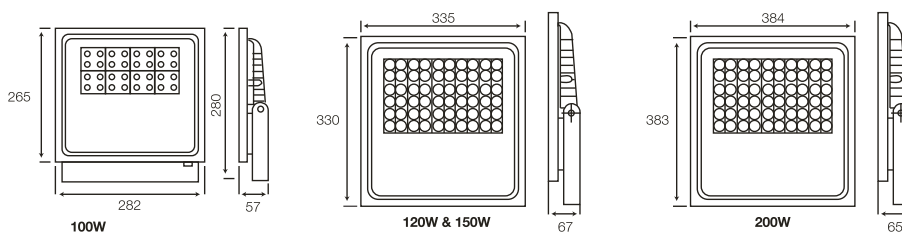

All dimensions are in mm. Tolerance ± 2 mm

ELECTRICAL & PACKING DATA

INGRESS PROTECTION **IP66**

| Cat. No.* | Luminaire Lumen OP (Lm) | Nominal System Wattage (W) | Rated Voltage (V) | Mains Current (A) | Case Lot (in nos) |
|--------------------|-------------------------|----------------------------|-------------------|-------------------|-------------------|
| LF20-122-060-57-G2 | 10000 | 100 | 240 | 0.43 | 01 |
| LF20-132-060-57-G2 | 12000 | 120 | 240 | 0.53 | 01 |
| LF20-192-060-57-G2 | 15000 | 150 | 240 | 0.69 | 01 |
| LF20-272-060-57-G2 | 20000 | 200 | 240 | 0.88 | 01 |

LED is an ever improving and evolving technology. Wipro is committed to bring you the best in LED technology. Data given is representative and can change.



AlphaLED Floodlight | LF 20

LED floodlight luminaire



APPLICATIONS



SPECIFICATIONS

- Aluminium die-cast housing, powder coated
- High efficiency, long life, LEDs
- High purity polycarbonate lenses for superior performance
- Toughened glass with silicon gaskets for IP66 protection
- Complete assembly with LED, driver and accessories pre-wired upto terminal block in connector compartment
- Integral control gear compartment with connector

INSTALLATION

- External cradle adjustable mounting arrangement suitable for mounting with 2 Nos.M8 Or 5/16' bolts

CONTROL GEAR

- In built integrated electronic LED driver

DIMENSION DRAWINGS

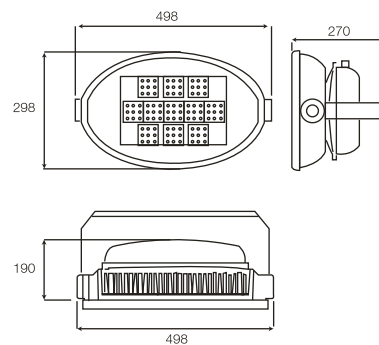

All dimensions are in mm. Tolerance ± 2 mm

ELECTRICAL & PACKING DATA

INGRESS PROTECTION **IP66**

| Cat. No.* | Luminaire Lumen OP (Lm) | Nominal System Wattage (W) | Rated Voltage (V) | Mains Current (A) | Case Lot (in nos) |
|--------------------|-------------------------|----------------------------|-------------------|-------------------|-------------------|
| LF20-342-060-57-G2 | 25000 | 250 | 240 | 1.15 | 01 |
| LF20-392-060-57-G2 | 30000 | 300 | 240 | 1.35 | 01 |
| LF20-442-060-57-G2 | 35000 | 350 | 240 | 1.50 | 01 |

LED is an ever improving and evolving technology. Wipro is committed to bring you the best in LED technology. Data given is representative and can change.

RevoLED Floodlight | LF 07

High efficiency LED floodlight



APPLICATIONS



SPECIFICATIONS

- High efficiency, long life, high power LED
- Aluminium housing with fins for efficient heat dissipation
- Highly efficient, specially designed glass lens optics
- Constant current LED Driver
- Complete assembly with LED, Driver and accessories pre-wired in driver compartment
- Removable control gear tray with a separate chamber for efficient heat dissipation

INSTALLATION

- External cradle adjustable mounting arrangement suitable for mounting with 2 Nos. M8 /5/16' bolts.

CONTROL GEAR

- In built integrated electronic LED driver

DIMENSION DRAWINGS

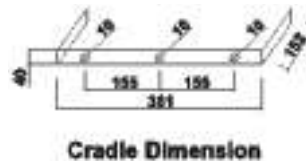
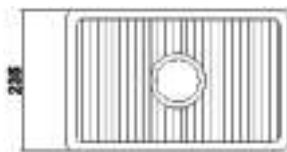
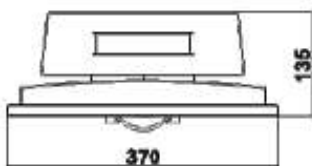

All dimensions are in mm. Tolerance ± 2 mm

ELECTRICAL & PACKING DATA

INGRESS PROTECTION **IP65**

| Cat. No.* | Luminaire Lumen OP (Lm) | Nominal System Wattage (W) | Rated Voltage (V) | Mains Current (A) | Approx. Weight (kg) | Case Lot (in nos) |
|--------------------|-------------------------|----------------------------|-------------------|-------------------|---------------------|-------------------|
| LF07-102-060-50-V5 | 13000 | 100 | 240 | 0.43 | 6.28 | 01 |
| LF07-102-090-50-V5 | 13048 | 100 | 240 | 0.43 | 6.28 | 01 |
| LF07-122-060-50-V5 | 15548 | 120 | 240 | 0.52 | 6.28 | 01 |
| LF07-122-090-50-V5 | 15548 | 120 | 240 | 0.52 | 6.28 | 01 |
| LF07-152-060-50-V5 | 18743 | 150 | 240 | 0.65 | 7.45 | 01 |
| LF07-152-090-50-V5 | 18810 | 150 | 240 | 0.65 | 7.45 | 01 |

*60 and 90 indicates beam angle in degrees.

LED is an ever improving and evolving technology. Wipro is committed to bring you the best in LED technology. Data given is representative and can change.



RevoLED Floodlight | LF 07

High efficiency LED floodlight



APPLICATIONS



SPECIFICATIONS

- High efficiency, long life, high power LED
- Aluminium housing with fins for efficient heat dissipation
- Highly efficient, specially designed glass lens optics
- Constant current LED Driver
- Complete assembly with LED, Driver and accessories pre-wired in driver compartment
- Removable control gear tray with a separate chamber for efficient heat dissipation

INSTALLATION

- External cradle adjustable mounting arrangement suitable for mounting with 2 Nos. M8 /5/16' bolts.

CONTROL GEAR

- In built integrated electronic LED driver

DIMENSION DRAWINGS

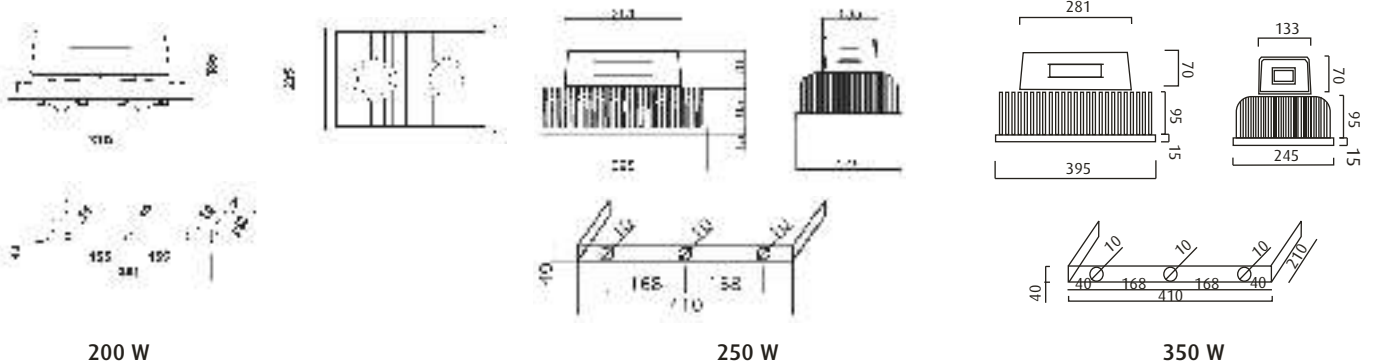

All dimensions are in mm. Tolerance ± 2 mm

ELECTRICAL & PACKING DATA

INGRESS PROTECTION **IP65**

| Cat. No.* | Luminaire Lumen OP (Lm) | Nominal System Wattage (W) | Rated Voltage (V) | Mains Current (A) | Approx. Weight (kg)* | Case Lot (in nos) |
|--------------------|-------------------------|----------------------------|-------------------|-------------------|----------------------|-------------------|
| LF07-282-060-50-V5 | 23989 | 200 | 240 | 0.87 | 7.95 | 01 |
| LF07-282-090-50-V5 | 24084 | 200 | 240 | 0.87 | 7.95 | 01 |
| LF07-272-060-50-V5 | 29982 | 250 | 240 | 1.1 | 12 | 01 |
| LF07-272-090-50-V5 | 30105 | 250 | 240 | 1.1 | 12 | 01 |
| LF07-472-060-50-V5 | 41961 | 350 | 240 | 1.5 | 17 | 01 |
| LF07-472-090-50-V5 | 42146 | 350 | 240 | 1.5 | 17 | 01 |
| LF07-582-060-50-V5 | 47691 | 415 | 240 | 1.8 | 17 | 01 |
| LF07-582-090-50-V5 | 47691 | 415 | 240 | 1.8 | 17 | 01 |

LED is an ever improving and evolving technology. Wipro is committed to bring you the best in LED technology. Data given is representative and can change.
 *60 and 90 indicates beam angle in degrees. Approx weight will be +/- 1.0 kg

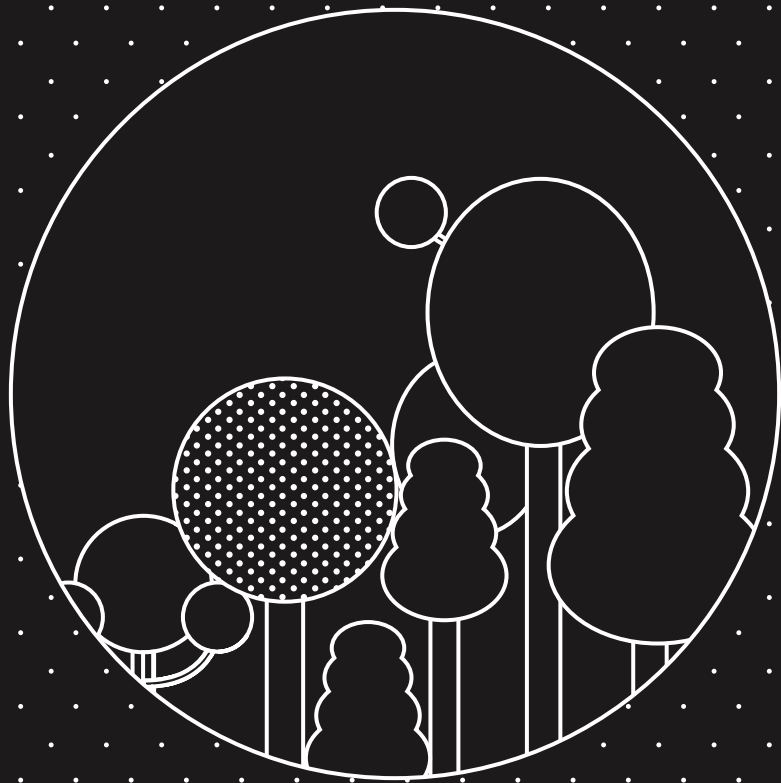



landscapes

UrbanoLED Pathway | LP 05

IP 66 LED pathway luminaire



APPLICATIONS



SPECIFICATIONS

- High-pressure die cast aluminium alloy body and components
- Luminaire anti-ageing electrostatic spray processed, Super resistance to corrosion
- Polycarbonate cover, high strength impact resistance
- Conforms to IS 10322 Part 5/Sec 1 : 1987

INSTALLATION

- Pole mounted

ACCESSORIES

- Pole to be ordered separately
- Pole Dia 76mm

DIMENSION DRAWINGS

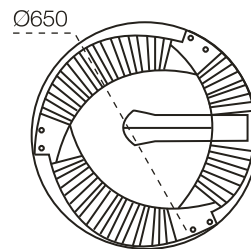

All dimensions are in mm. Tolerance ± 2 mm

ELECTRICAL & PACKING DATA

INGRESS PROTECTION **IP66**

| Cat. No. | Lumen Output (Lm) | Luminaire Wattage (W) | Mains Current (A) | Rated Voltage (V) | Case lot (in nos.) |
|--------------------|-------------------|-----------------------|-------------------|-------------------|--------------------|
| LP05-711-XXX-57-XX | 4982 | 60 | 0.26 | 240 | 01 |

LED is an ever improving and evolving technology. Wipro is committed to bring you the best in LED technology. Data given is representative and can change.



UrbanoLED Pathway | LP 06

IP 66 LED pathway luminaire



APPLICATIONS



SPECIFICATIONS

- High-pressure die cast aluminium alloy body
- High efficiency, long life, LEDs
- Lenses for superior performance
- Toughened glass cover with IP66 protection

INSTALLATION

- Pole mounted

ACCESSORIES

- Pole to be ordered separately
- Pole Dia 60-76mm

DIMENSION DRAWINGS

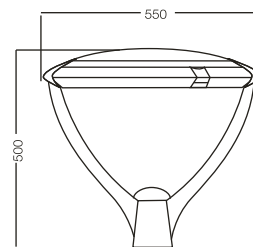

All dimensions are in mm. Tolerance ± 2 mm

ELECTRICAL DATA

INGRESS PROTECTION **IP66**

| Cat. No. | Lumen Output (Lm) | Luminaire Wattage (W) | Mains Current (A) | Rated Voltage (V) | Case lot (in nos.) |
|--------------------|-------------------|-----------------------|-------------------|-------------------|--------------------|
| LP06-351-XXX-57-XX | 2874 | 35 | 0.15 | 240 | 01 |

LED is an ever improving and evolving technology. Wipro is committed to bring you the best in LED technology. Data given is representative and can change.





Post TopLED | LP 02

IP 65 aesthetically appealing vintage LED post top



APPLICATIONS



SPECIFICATIONS

- Die cast aluminium housing in Pure Polyester UV resistant powder coated grey finish
- Top maintainable product with top opening die cast cover
- Anti-corrosive stainless steel screws & silicon gasket
- HET PMMA diffuser
- IP65 Protection
- Driver duly wired up to terminal block
- Conforms to IS 10322 Part 5/Sec 1:1987

INSTALLATION

- Luminaire is suitable for pole diameter of 65-75 mm. (Pole is not in Wipro's scope)
- Cable entry through pole from bottom
- In- built electronic LED driver
- 2 way 10Amps GFP mains connector

ACCESSORIES

- Pole to be ordered separately
- Pole Dia 76mm

DIMENSION DRAWINGS

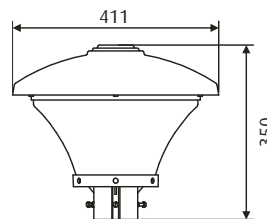

All dimensions are in mm. Tolerance ± 2 mm

ELECTRICAL DATA

INGRESS PROTECTION **IP65**

| Cat. No. | Lumen Output (Lm) | Luminaire Wattage (W) | Mains Current (A) | Rated Voltage (V) | Approx Weight (Kg) | Case lot (in nos.) |
|--------------------|-------------------|-----------------------|-------------------|-------------------|--------------------|--------------------|
| LP02-501-XXX-57-XX | 3524 | 45 | 0.2 | 240 | 4.9 | 01 |

*Other color temperature available on request

LED is an ever improving and evolving technology. Wipro is committed to bring you the best in LED technology. Data given is representative and can change.

Fantasy LED Bollard | CRLA 11

IP 65 LED bollard suitable for landscape lighting



APPLICATIONS



SPECIFICATIONS

- MS housing 2mm wall thickness & black matt powder coated
- Special translucent PMMA milky tube for better light transmission
- High Luminous flux imported LEDs for better light output
- Product is designed for IP 65 protection
- Electronic control gear duly wired up to the terminal block
- Designed and manufactured to comply with IS 10322 part 5/Sec 1 1987

INSTALLATION

- Designed for installation by fixing the base on a solid flat surface using rawl plugs or cemented fastening screws



DIMENSION DRAWINGS

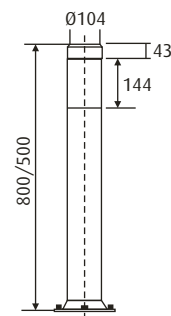

All dimensions are in mm. Tolerance ± 2 mm

ELECTRICAL & PACKING DATA

INGRESS PROTECTION **IP65**

| Cat. No. | Luminaire Lumen OP | Luminaire Wattage (W) | Rated Voltage (V) | Mains Current (A) | Approx. Weight (kg) | Case lot (in nos.) |
|------------------|--------------------|-----------------------|-------------------|-------------------|---------------------|--------------------|
| CRLA11008HP27-08 | 560 | 8 | 240 | 0.037 | 3 | 01 |
| CRLA11008HP57-08 | 560 | 8 | 240 | 0.037 | 3 | 01 |
| CRLA11008HP27-05 | 560 | 8 | 240 | 0.037 | 2 | 01 |
| CRLA11008HP57-05 | 560 | 8 | 240 | 0.037 | 2 | 01 |

LED is an ever improving and evolving technology. Wipro is committed to bring you the best in LED technology. Data given is representative and can change.



GardeniaLED | LF 05

IP 67 integral LED bushlight/inground



APPLICATIONS



SPECIFICATIONS

- Die cast aluminium, compact, aesthetic, pure polyester powder coated housing
- IP 67, optically sealed housing with toughened glass totally sealed using silicon gasket ensuring IP and lifelong performance
- High efficiency COB LED mounted on black anodised aluminum heat sink for effective heat dissipation
- Special high efficiency optical grade UV stabilized engineering plastic reflector
- Available in 10, 24, 36 & 55 deg. beam angle
- Front maintainable with vandal resistant toughened glass giving access to driver and LED
- Anti corrosive stainless steel hardware facilitates maintenance
- Conforms to IS 10322 Part 5/ Sec.1:1987
- Complete with LEDs and driver pre-wired up to terminal block
- 2 way 10Amps GFP mains connector

INSTALLATION

- Cradle mounting

ACCESSORIES

- Directional shield, Wipro Cat No. FFX 511
- Earth spike in die cast aluminum, Wipro Cat No. FFX 512

DIMENSION DRAWINGS

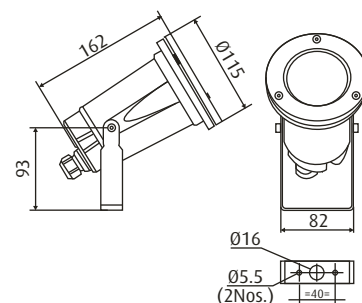

All dimensions are in mm. Tolerance ± 2 mm

ELECTRICAL & PACKING DATA

INGRESS PROTECTION **IP67**

| Cat No. | Lumen Output (Lm) | Luminaire wattage (W) | Input voltage | Approx. Weight (kg) | Case lot (nos) | Beam Angle (Deg) |
|--------------------|-------------------|-----------------------|---------------|---------------------|----------------|------------------|
| LF05-450-024-27-XX | 450 | 6 | 240 | 1.5 | 1 | 24 |
| LF05-450-036-27-XX | 450 | 6 | 240 | 1.5 | 1 | 36 |
| LF05-450-055-27-XX | 450 | 6 | 240 | 1.5 | 1 | 55 |
| LF05-600-024-27-XX | 600 | 8 | 240 | 1.5 | 1 | 24 |
| LF05-600-036-27-XX | 600 | 8 | 240 | 1.5 | 1 | 36 |
| LF05-600-055-27-XX | 600 | 8 | 240 | 1.5 | 1 | 55 |

*For RGB, order controller LG70-004. Extra cable length (for RGB) per metre available
 LED is an ever improving and evolving technology. Wipro is committed to bring you the best in LED technology. Data given is representative and can change.





Wipro Lighting brings to you highly energy efficient and high performance Cleanray range of LED luminaires for indoors and outdoors. This range not only creates stunning interiors but also vibrant outdoors. Now illuminate with more savings!

ElateLED | CRCO 10

Recess mounted LED luminaire with complete diffuser

APPLICATIONS



FEATURES & BENEFITS

Clutter free ceiling

Luminaire blends unobtrusively with the ceiling and seamless profile gives a neat, clean and clutter free look to the ceiling enhancing the overall appearance of the space.

Enhanced performance

High efficiency LED grade diffuser ensures better light transmission and perfect diffusion of light. Thus enhances the work environment.

Visual Harmony

A soft and soothing light with uniform illumination enriches the work environment that helps in achieving the work task productivity.

High Efficacy LEDs

High efficacy LEDs ensures optimum light output with less energy consumption and lesser Light Power Density(LPD).



SPECIFICATIONS

- White powder coated housing & frame in CRCA sheet
- High efficiency LED grade diffuser
- High efficacy LEDs for better light output
- Electronic driver pre-wired upto the terminal block
- Designed and manufactured to comply with IS 10322 part 5/Sec 1 19877

INSTALLATION

- Suitable for modular ceiling system

ACCESSORIES

- For Gypsum/POP applications additional frame needs to be ordered separately. Order 9180P01025 for aluminium. Or order 9180P01089 for M.S. Case lot 10 pcs/box.

DIMENSION DRAWINGS

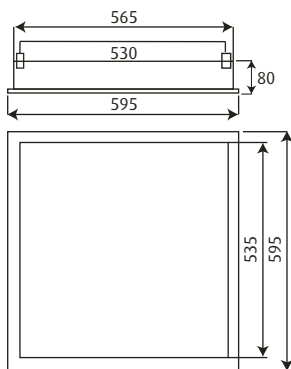

All dimensions are in mm Tolerance: ± 2 mm

ELECTRICAL & PACKING DATA

INGRESS PROTECTION **IP20**

| Cat. No.* | Luminaire Lumen Output (Lm) | Luminaire Wattage (W) | Rated Voltage (V) | Mains Current (A) | Case Lot (in nos) |
|------------------|-----------------------------|-----------------------|-------------------|-------------------|-------------------|
| CRCO10R038HP57GL | 3160 | 36 | 240 | 0.18 | 02 |

*57 represents 5700 K. Other colour temperatures available on request.



ImmaculateLED Slim | CRCO 23

Recess mounted slim LED luminaire



APPLICATIONS



SPECIFICATIONS

- Extruded aluminium white powder coated housing
- Edge lit optics from reflector+light guide plate+diffuser configuration
- Low wattage high efficient LEDs
- Electronic LED driver prewired upto terminal block
- Excellent heat dissipation through direct contact
- Designed and manufactured to comply with IS 10322 part 5/Sec 1 2012

INSTALLATION

- Suitable for Armstrong/CRG/TRAC/USG/Celotex

*Please get in touch with Wipro Team on POP installation

DIMENSION DRAWINGS

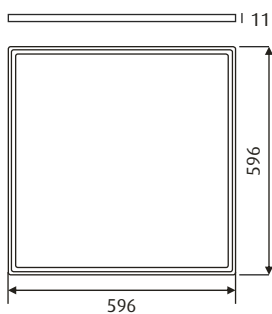

Cutout : 570 mm x 570 mm

All dimensions are in mm. Tolerance ± 2 mm

ELECTRICAL & PACKING DATA

INGRESS PROTECTION **IP20**

| Cat. No.* | Luminaire Lumen OP (Lm) | Nominal System Wattage (W) | Rated Voltage (V) | Mains Current (A) | Case Lot (in nos) |
|------------------|-------------------------|----------------------------|-------------------|-------------------|-------------------|
| CRCO23R036HP65G1 | 3000 | 36 | 240 | 0.16 | 02 |

LED is an ever improving and evolving technology. Wipro is committed to bring you the best in LED technology. Data given is representative and can change.

IrisLED Slim RO | LD 80

Recessed mounted round slim panel LED downlighter



APPLICATIONS



SPECIFICATIONS

- White powder coated pressure die cast aluminium housing and bottom frame
- Slim luminaire with high transmittive LGP technology
- High efficiency, non-yellowing PMMA diffuser
- Excellent thermal management with die cast aluminium construction
- Specially designed, easy to install mounting clips
- Complete with LEDs, Driver and accessories prewired up to terminal block
- Suitable for Armstrong/CRG/TRAC/USG/Celotex/ POP modular ceiling system



INSTALLATION

- Provision for mounting with the help of spring loaded SS mounting clips
- Suitable for surface mounting

CONTROL GEAR OPITON

- Electronic LED driver

DIMENSION DRAWINGS

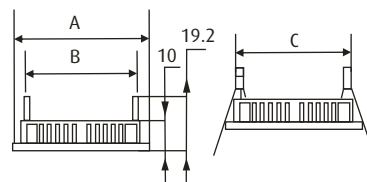

| Wattages | A | B | C | Cutout Dimensions |
|----------|-----|-----|-------|-------------------|
| 3W | 85 | 75 | 70.48 | Ø 75 |
| 6W | 120 | 100 | 108 | Ø 108 |
| 9W | 150 | 135 | 135 | Ø 135 |
| 12W | 170 | 150 | 157 | Ø 157 |
| 15W | 198 | 172 | 178 | Ø 178 |
| 18W | 225 | 200 | 206 | Ø 205 |

All dimensions are in mm. Tolerance ± 2 mm

ELECTRICAL & PACKING DATA

INGRESS PROTECTION **IP20**

| Cat. No.* | Luminaire Lumen Output (Lm) | Luminaire Wattage (W) | Rated Voltage (V) | Mains Current (A) | Approx. Weight (kg) | Case Lot (in nos) |
|--------------------|-----------------------------|-----------------------|-------------------|-------------------|---------------------|-------------------|
| LD80-200-XXX-60-XX | 190 | 3 | 240 | 0.018 | 0.104 | 30 |
| LD80-350-XXX-60-XX | 430 | 6 | 240 | 0.026 | 0.154 | 18 |
| LD80-530-XXX-40-XX | 645 | 9 | 240 | 0.039 | 0.270 | 18 |
| LD80-101-XXX-60-XX | 1000 | 12 | 240 | 0.053 | 0.398 | 12 |
| LD80-131-XXX-40-XX | 1260 | 15 | 240 | 0.065 | 0.460 | 12 |
| LD80-171-XXX-60-XX | 1580 | 18 | 240 | 0.079 | 0.670 | 6 |

*60 represents 6000 K. Other colour temperatures available on request.

IrisLED Slim RO SM | LD 80

Surface mounted round slim panel LED downlighter



APPLICATIONS



SPECIFICATIONS

- White powder coated, pressure die cast aluminum housing
- High transmittivity, non-yellowing PMMA diffuser
- Excellent thermal management with aluminum construction
- Specially designed, easy to install mounting clips
- Complete with LEDs, Driver and accessories pre-wired up to terminal block
- Design and manufactured to comply with IS10322 part 5/sec 1987

INSTALLATION

- Suitable for surface mounting

CONTROL GEAR OPITON

- Integrated electronic control gear

DIMENSION DRAWINGS

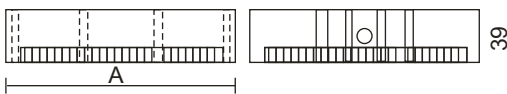

| Wattages | A |
|----------|-----|
| 6W | 120 |
| 12W | 170 |
| 18W | 225 |

ELECTRICAL & PACKING DATA

INGRESS PROTECTION **IP20**

| Cat. No.* | Luminaire Lumen Output (Lm) | Luminaire Wattage (W) | Rated Voltage (V) | Mains Current (A) | Approx. Weight (kg) | Case Lot (in nos) |
|--------------------|-----------------------------|-----------------------|-------------------|-------------------|---------------------|-------------------|
| LD80-350-XXX-60-SM | 430 | 6 | 240 | 0.026 | 0.191 | 18 |
| LD80-101-XXX-60-SM | 1000 | 12 | 240 | 0.053 | 0.424 | 12 |
| LD80-171-XXX-60-SM | 1580 | 18 | 240 | 0.079 | 0.597 | 06 |

*60 represents 6000 K. Other colour temperatures available on request.

IrisLED Slim SQ | LD 81

Recess mounted square slim LED luminaire



APPLICATIONS



SPECIFICATIONS

- White powder coated pressure die cast aluminum housing and bottom frame
- Slim luminaire with high transmittive LGP technology
- High efficiency, non-yellowing PMMA diffuser
- Excellent thermal management with die cast aluminum construction
- Specially designed, easy to install mounting clips
- Complete with LEDs, Driver and accessories pre-wired up to terminal block
- Suitable for Armstrong/ CRG/ TRAC/ USG/ Celotex/ POP modular ceiling system



INSTALLATION

- Provision for mounting with the help of spring loaded SS mounting clips
- Suitable for surface mounting

CONTROL GEAR OPTION

- Electronic LED driver

DIMENSION DRAWINGS

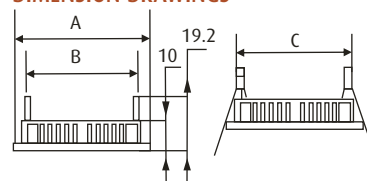

| Wattages | A | B | C | Cutout Dimensions |
|----------|-----|-----|-------|-------------------|
| 3W | 85 | 75 | 70.48 | 75 x 75 |
| 6W | 120 | 100 | 108 | 108 x 108 |
| 9W | 150 | 135 | 135 | 135 x 135 |
| 12W | 170 | 150 | 157 | 157 x 157 |
| 18W | 225 | 206 | 206 | 178 x 178 |
| 24W | 298 | 273 | 279 | 227 x 227 |

All dimensions are in mm. Tolerance ± 2 mm

ELECTRICAL & PACKING DATA

INGRESS PROTECTION **IP20**

| Cat. No.* | Luminaire Lumen Output (Lm) | Luminaire Wattage (W) | Rated Voltage (V) | Mains Current (A) | Approx. Weight (kg) | Case Lot (in nos) |
|--------------------|-----------------------------|-----------------------|-------------------|-------------------|---------------------|-------------------|
| LD81-200-XXX-60-XX | 180 | 3 | 240 | 0.013 | 0.12 | 30 |
| LD81-350-XXX-60-XX | 415 | 6 | 240 | 0.026 | 0.19 | 18 |
| LD81-530-XXX-60-XX | 630 | 9 | 240 | 0.039 | 0.25 | 18 |
| LD81-101-XXX-60-XX | 1000 | 12 | 240 | 0.053 | 0.53 | 18 |
| LD81-131-XXX-60-XX | 1212 | 15 | 240 | 0.065 | 0.40 | 12 |
| LD81-171-XXX-60-XX | 1525 | 18 | 240 | 0.079 | 0.54 | 06 |
| LD81-200-XXX-60-XX | 2048 | 24 | 240 | 0.105 | 1.18 | 10 |

*60 represents 6000 K. Other colour temperatures available on request.

IrisLED Slim SQ SM | LD 81

Surface mounted square slim LED luminaire



APPLICATIONS



SPECIFICATIONS

- White powder coated, pressure die cast aluminum housing
- High transmittivity, non-yellowing PMMA diffuser
- Excellent thermal management with aluminum construction
- Specially designed, easy to install mounting clips
- Complete with LEDs, Driver and accessories pre-wired up to terminal block
- Design and manufactured to comply with IS10322 part 5/sec 1987

INSTALLATION

- Suitable for surface mounting

CONTROL GEAR OPITON

- Integrated electronic control gear

DIMENSION DRAWINGS

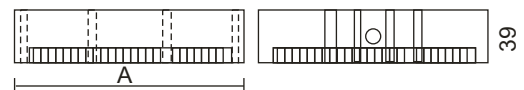

| Wattages | A |
|----------|-----|
| 6W | 120 |
| 12W | 170 |
| 18W | 225 |

All dimensions are in mm. Tolerance ± 2 mm

ELECTRICAL & PACKING DATA

INGRESS PROTECTION **IP20**

| Cat. No.* | Luminaire Lumen Output (Lm) | Luminaire Wattage (W) | Rated Voltage (V) | Mains Current (A) | Approx. Weight (kg) | Case Lot (in nos) |
|--------------------|-----------------------------|-----------------------|-------------------|-------------------|---------------------|-------------------|
| LD81-350-XXX-60-SM | 415 | 6 | 240 | 0.026 | 0.19 | 18 |
| LD81-101-XXX-60-SM | 1000 | 12 | 240 | 0.053 | 0.53 | 12 |
| LD81-171-XXX-60-SM | 1525 | 18 | 240 | 0.079 | 0.75 | 06 |

*60 represents 6000 K. Other colour temperatures available on request.

TrimLED NEO | LL 20

LED batten suitable for indoor applications

APPLICATIONS



SPECIFICATIONS

- High efficiency LEDs for optimum light output and savings in power
- Specially designed extruded polycarbonate housing
- High optically efficient diffuser
- Excellent design ensures uniform lighting and avoids direct view of LEDs

INSTALLATION

- Mounting SS clamp provided with product

CONTROL GEAR

- In-built electronic LED driver

DIMENSION DRAWINGS

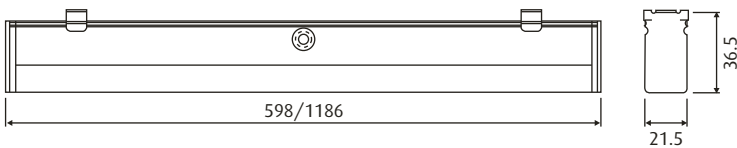

598 mm for 10 W; 1186 mm for 18 W

All dimensions are in mm. Tolerance ± 2 mm

ELECTRICAL & PACKING DATA

INGRESS PROTECTION **IP20**

| Cat. No.* | Luminaire Lumen Output (Lm) | Luminaire Wattage (W) | Rated Voltage (V) | Mains Current (A) | Approx. Weight (kg) |
|--------------------|-----------------------------|-----------------------|-------------------|-------------------|---------------------|
| LL20-111-XXX-65-NE | 900 | 10 | 240 | 0.07 | 0.15 |
| LL20-221-XXX-65-NE | 1800 | 18 | 240 | 0.07-0.11 | 0.20 |

TrimLED | LL 20

High efficiency LED aluminium linear batten



APPLICATIONS



SPECIFICATIONS

- High efficiency LEDs for optimum light output and savings in power
- Specially designed Extruded powder coated aluminium housing
- High optically efficient diffuser
- Excellent design ensures uniform lighting and avoids direct view of LEDs

INSTALLATION

- Mounting clamp provided with product

CONTROL GEAR

- In-built Electronic LED driver

DIMENSION DRAWINGS

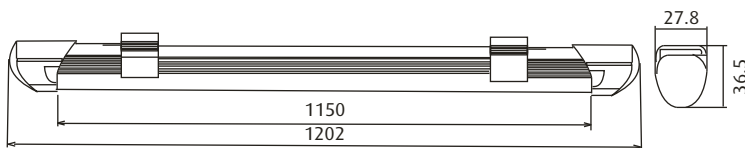

All dimensions are in mm. Tolerance ± 2 mm

ELECTRICAL & PACKING DATA

INGRESS PROTECTION **IP20**

| Cat. No.* | Luminaire Lumen Output (lm) | Luminaire Wattage (W) | Rated Voltage (V) | Mains Current (A) |
|--------------------|-----------------------------|-----------------------|-------------------|-------------------|
| LL20-281-XXX-65AL1 | 2001 | 20 | 240 | 0.09 |

ProLED | LL 13

High efficiency LED linear lamp



APPLICATIONS



SPECIFICATIONS

- High efficiency LEDs for optimum light output and savings in power
- Specially designed polycarbonate housing
- Excellent design ensures uniform lighting and avoids direct view of LEDs
- Short circuit and surge protection for enhanced reliability and longer service life of driver

INSTALLATION

- Mounting with G-13 lamp holder provided with the product

CONTROL GEAR

- In-built electronic LED driver

DIMENSION DRAWINGS

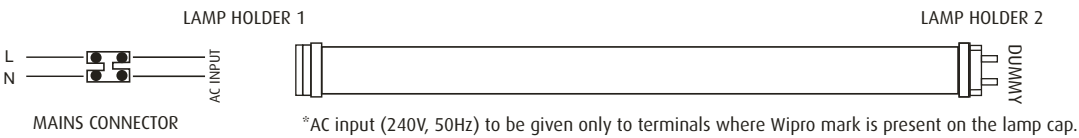

All dimensions are in mm. Tolerance ± 2 mm

ELECTRICAL & PACKING DATA

INGRESS PROTECTION **IP20**

| Cat. No.* | Luminaire Lumen Output (Lm) | Luminaire Wattage (W) | Rated Voltage (V) | Mains Current (A) | Case Lot (in nos) |
|---------------|-----------------------------|-----------------------|-------------------|-------------------|-------------------|
| LL13-181-650 | 1800 | 18 | 240 | 0.08 | 20 |
| LL13-181-65SE | 2000 | 20 | 240 | 0.09 | 20 |

ProLED Compact | LL 18

High efficiency LED compact lamp



APPLICATIONS



SPECIFICATIONS

- High efficiency LEDs and in-built electronic LED driver for optimum light output
- Polycarbonate end caps and specially designed aluminium housing for excellent heat dissipation
- Short circuit and surge protection for enhanced reliability and longer service life of driver
- Optical design ensures uniform lighting and avoids direct view of LEDs
- Specially designed for durable performance

INSTALLATION

- 2G11 4pin Lamp holder

CONTROL GEAR

- In-built Electronic LED driver

DIMENSION DRAWINGS

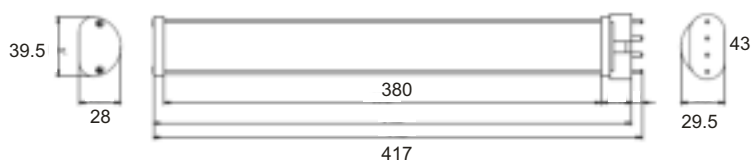

All dimensions are in mm. Tolerance ± 2 mm

ELECTRICAL & PACKING DATA

INGRESS PROTECTION **IP20**

| Cat. No.* | Luminaire Lumen Output (Lm) | Luminaire Wattage (W) | Rated Voltage (V) | Mains Current (A) |
|---------------|-----------------------------|-----------------------|-------------------|-------------------|
| LL18-181-65PL | 1800 | 18 | 240 | 0.07-0.09 |

ProLED T5 | LL 13

High efficiency LED linear lamp

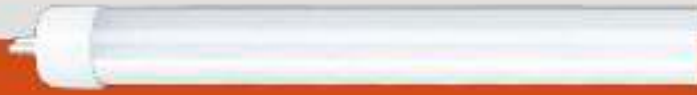

APPLICATIONS



SPECIFICATIONS

- High efficiency LEDs for optimum light output and savings in power
- Specially designed aluminum housing for excellent heat dissipation
- Excellent design ensures uniform lighting and avoids direct view of LEDs

CONTROL GEAR

- Separate non-integral electronic LED driver

DIMENSION DRAWINGS

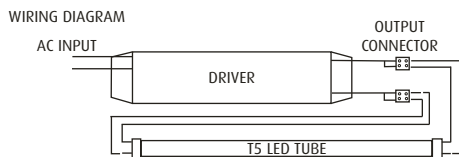
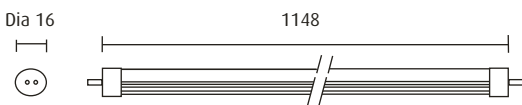

All dimensions are in mm. Tolerance ± 2 mm

ELECTRICAL & PACKING DATA

INGRESS PROTECTION **IP20**

| Cat. No.* | Luminaire Lumen Output (Lm) | Luminaire Wattage (W) | Rated Voltage (V) | Mains Current (A) | Case Lot (in nos) |
|----------------|-----------------------------|-----------------------|-------------------|-------------------|-------------------|
| LL13-181-65-T5 | 1800 | 18 | 240 | 0.08 | 10 |

WIOLED | WIO 92



Channel suitable for Pro LED lamp

APPLICATIONS



SPECIFICATIONS

- Sleek design in high quality polyester white pre-coated galvanized steel
- Soft contoured injection moulding plastic end caps
- Suitable for 1 x 18W/20W and 2 x 18W/20W ProLED Lamp
- Conforms to IS 10322 Part 5 / Sec 1:1987.

INSTALLATION

- Individual two point surface mounting on ceiling/wall
- Ceiling suspension using 19 mm OD rigid conduit pipe on two knock outs provided on channel

ACCESSORIES

- Snap fit polycarbonate lamp holders
- 3-way 5 amp GFP mains connector for incoming cable
- Suitable for 19 mm ET cable entry

DIMENSION DRAWINGS

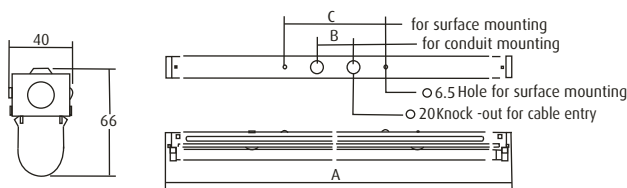

| Cat. No. | A | B | C |
|------------|------|---------|---------|
| WIO 921208 | 1230 | 600 C/C | 680 C/C |

All dimensions are in mm. Tolerance ± 2 mm

ELECTRICAL & PACKING DATA

INGRESS PROTECTION **IP20**

| Cat. No.* | Suitable for | Rated Voltage (V) | Mains Current (A) | Case Lot (in nos) |
|------------|--------------------|-------------------|-------------------|-------------------|
| WIO 921208 | Single 4 feet lamp | 240 | 0.09 | 20 |
| WIO 922208 | Twin 4 feet lamp | 240 | 0.18 | 20 |

Please order suitable ProLED tube separately

skylineLED | LR 02

High performance LED streetlight suitable for primary/secondary roads



APPLICATIONS



SPECIFICATIONS

- Aluminium pressure die-cast housing for long life
- Pure polyester powder coated dark gray housing
- High efficiency, long life LEDs
- High purity PC fresnel diffuser with silicon gaskets
- Complete assembly with LEDs, driver and accessories pre-wired up to terminal block. Driver cover designed to suit top maintenance

INSTALLATION

- Suitable for external pole dia. up to 35mm
- 3 way 10 Amp connector provided for quick connections

CONTROL GEAR

- In built integrated electronic LED driver



DIMENSION DRAWINGS

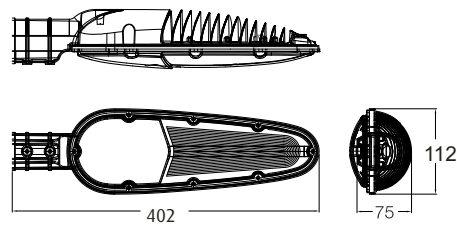

All dimensions are in mm. Tolerance ± 2 mm

ELECTRICAL & PACKING DATA

INGRESS PROTECTION **IP66**

| Cat. No.* | Luminaire Lumen Output (Lm) | Luminaire Wattage (W) | Rated Voltage (V) | Mains Current (A) | Case Lot (in nos) |
|--------------------|-----------------------------|-----------------------|-------------------|-------------------|-------------------|
| LR02-261-XXX-57-XX | 1900 | 20 | 240 | 0.09 | 08 |

AlphaLED Floodlight | LF 19

Integral cradle mount high performance LED floodlight



APPLICATIONS



SPECIFICATIONS

- Aluminium die cast housing and frame with powder coating
- High efficiency, long life, LEDs
- 4 x 1 diffused reflector with 60° Beam made of optical grade polycarbonate for super performance
- Toughened glass with silicon gaskets for IP66 Protection
- Complete assembly with LED, Driver and accessories pre-wired up to terminal block in connector compartment with PG7 cable gland
- Integral control gear compartment with connector

INSTALLATION

- External cradle adjustable mounting arrangement suitable for mounting with 2 Nos. M8 /5/16' bolts.

CONTROL GEAR

- In built integrated electronic LED driver

DIMENSION DRAWINGS

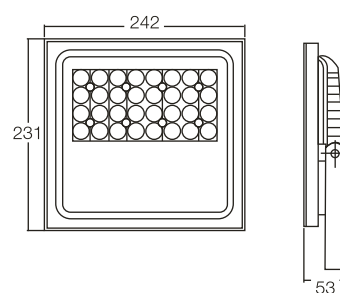

All dimensions are in mm. Tolerance ± 2 mm



ELECTRICAL & PACKING DATA

INGRESS PROTECTION **IP66**

| Cat. No.* | Luminaire Lumen Output (Lm) | Luminaire Wattage (W) | Rated Voltage (V) | Mains Current (A) | Case Lot (in nos) |
|--------------------|-----------------------------|-----------------------|-------------------|-------------------|-------------------|
| LF19-471-060-57-XX | 3995 | 40 | 240 | 0.7 | 01 |

LED is an ever improving and evolving technology. Wipro is committed to bring you the best in LED technology. Data given is representative and can change.

MoonLED | LW 01/02

Circular/square LED wall/ceiling light



APPLICATIONS



SPECIFICATIONS

- High efficacy and long life LEDs
- Housing made of ABS plastic with white finish
- CRCA reflector with white powder coated finish
- High Efficiency Translucence (HET) diffuser
- Outer rim is made of ABS plastic and white finish
- Easy to mount on true ceiling and quick to service
- Driver duly wired up to the terminal block
- Designed and manufactured to comply with IS 10322 part 5/Sec 1 1987

INSTALLATION

- Suitable for surface/wall mounting



DIMENSION DRAWINGS

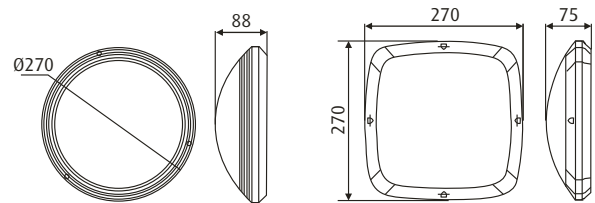

All dimensions are in mm. Tolerance ± 2 mm

ELECTRICAL & PACKING DATA

INGRESS PROTECTION **IP65**

| Cat. No.* | Luminaire Lumen OP (W) | Luminaire Wattage (W) | Rated Voltage (V) | Mains Current (A) | Approx. Weight (kg) | Case Lot (in nos) |
|--------------------|------------------------|-----------------------|-------------------|-------------------|---------------------|-------------------|
| LW01-101-XXX-60-XX | 650 | 9 | 240 | 0.06 | 1.25 | 10 |
| LW02-101-XXX-60-XX | 650 | 9 | 240 | 0.057 | 1.5 | 10 |

FormzLED | LS 06

IP 20 Non-integral flexible LED strip light

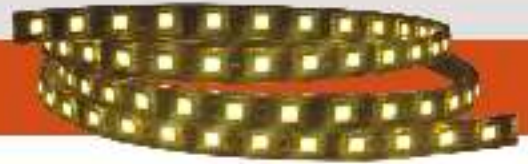

APPLICATIONS



SPECIFICATIONS

- Solid state high brightness SMD LED chips
- Available in LED power of 4.8W per meter and 14.4 per meter versions
- Can be cut at marked intervals to suit desired lengths
- LS06 series with IP 20 is suitable for indoor applications and LS26 series with IP 65 rating is suitable for outdoor applications
- View angle of 120 degree

INSTALLATION

- Designed for installation by adhesive back peel for easy installation

ACCESSORIES

- Suitable driver to be ordered separately

ELECTRICAL & PACKING DATA

INGRESS PROTECTION **LS06 IP20**

| Cat. No.* | Luminaire Wattage (W) | Supply Voltage (V) | LED Qty/Meter | Length*(m) | Color |
|--------------------|-----------------------|--------------------|---------------|------------|------------|
| LS06-005-120-WH-50 | 5W per meter | 12 | 60 | 5 | White |
| LS06-005-120-WW-50 | 5W per meter | 12 | 60 | 5 | Warm White |
| LS06-015-120-WH-50 | 15W per meter | 12 | 60 | 5 | White |
| LS06-015-120-WW-50 | 15W per meter | 12 | 60 | 5 | Warm White |

*Each unit is of 5 mts

DRIVER SPECIFICATIONS

| Cat. No. | Input/Output Voltage | IP Rating | Output Wattage/Output Current | Dimensions in mm (L x B x H) | Suitability |
|----------|----------------------|-----------|-------------------------------|------------------------------|----------------------------------|
| LG40-024 | 240V AC/12V | IP20 | 24W/2Amps | 95 x 61 x 41 | 1 unit for 1no. of LS06/LS26-005 |
| LG40-078 | 240V AC/12V | IP20 | 78W/6.5Amps | 185 x 90 x 54 | 1 unit for 1no. of LS06/LS26-015 |

Order driver separately. Driver is for indoor use only. Single driver for 1 unit (5 meters) of FormzLED

LED is an ever improving and evolving technology. Wipro is committed to bring you the best in LED technology. Data given is representative and can change.

Guide to pictograms



AIRPORTS



CAR PARKING



EXCLUSION AREA



FOOTPATH



AUTOMOBILE SHOWROOMS



COLUMN LIGHTING



DOME LIGHTING



GARAGE



BANKS



CONFERENCE



ELECTRONIC AND OPTICAL EQUIPMENT



GARDEN



BEVERAGES



CONSTRUCTION SITE



ENTRANCE AREA



CLASS AREA



B.G. TECHNOLOGY



CONVEYOR BELT



ENTRANCE CANOPY



HIGHWAYS



CANTERNA



CORRIDOR



EXHIBITION GALLERY



HOSPITAL



CAMP SITE LIGHTING



CAMP LIGHTING



FAÇADE LIGHTING



CUT



JEWELLERY SHOP



PARK



RAILWAY



STADIUM



LECTURE HALL



PERIMETER LIGHTING



RECEPTION AREA



STORAGE WAREHOUSE



LOBBY



PETROL PUMP



RESIDENTIAL AREA



STORAGE AREA



LOCAL ROAD



PHARMACEUTICAL



RESORT



SWIMMING POOL



MANUFACTURING PLANT



PORT



RETAIL & ENTERTAINMENT



THEATRE



MONUMENT LIGHTING



DOME LIGHTING



SECONDARY ROAD



TOWNSHIP



OFFICE



ELEVATOR ACCESS



SERVICE AREA



WAITING ROOM

Contact Information

Business Office:

Wipro Lighting, 5 floor, Godrej Eternia - C, old Pune-Mumbai road, Shivajinagar, Pune - 411 005
Tel: 020-66098700, Fax: 020-66098777, E-mail : helpdesk.lighting@wipro.com

Registered Office:

Wipro Enterprises Ltd. #134, Doddakannelli, Sarjapur road, next to Wipro corporate office, Bangalore - 560035
Tel : 080-28440011, Fax : 080-28440057

www.wiprolighting.com

Toll-free no: 1800-425-1969

Follow us on    

Branch Offices

Delhi

E-40/7, Okhla Industrial Area, Phase-II,
New Delhi - 110 020
Tel: 011-4170 8121/29

Bangalore

No.139, 7th Cross, N S Palya, off. Bannerghatta Road,
Bangalore - 560 076
Tel: 080-4150 3260

Kolkata

3, Pretoria Street, 3rd floor, **Kolkata - 700 071**
Tel: 033-4404 5886/87

Hyderabad

Plot No.,13 A/1, Road No. 9, IDA East Division Nacharam,
R.R.Dist.,**Hyderabad - 500 076**
Tel: 040-2717 6082

Mumbai

1401/1402, 14 Floor, C-wing Lotus Corporate Park,
Goregaon (East) Mumbai - 400 083
Tel: 022-6218 2000

Chennai

Economist House, S-15, First Cross Road,
Thiru Vi Ka Industrial Estate, Guindy
Chennai - 600 032
Tel: 95660 86333

Pune

Bhosale Heights, 1195/5, Fergusson College Road,
Pune - 411 005
Tel: 020-2553 5081



delighted
to assist

just dial 1800-425-1969

Chandigarh

S . C . O. - 208 - 209, 3rd Floor Sector - 34 A,
Chandigarh - 160 022
Tel: 0172-501 8734

Lucknow

E/149, Transport Nagar, Lucknow Kanpur Road,
Lucknow - 226 012
Tel: 0522-2434 352

Ahmedabad

H-409, Titanium City Centre, 100 ft. Road, Anand Nagar
Ahmedabad - 380 015
Tel: 079-4007 3546

Raipur

Khasra No.48.49/2, khedia Business Park, Tatibanth
Raipur (CG) - 492 099
Tel: 0771-3265 725

Vishakhapatnam

1-99, Sirigudi Nagar, Yendada
Vishakhapatnam - 530 045
Tel: 96769 08080

Coimbatore

No.41, Chokkampudur Main Road, Sriram Nagar,
Telungupalayam Post, Coimbatore - 641 039
Tel: 98947 95836

Jaipur

B - 16/17, Palsania Complex, Near T B Hospital,
Subhash Nagar Shopping Centre, Jaipur - 320 016
Tel: 0141-2280 014/4910879

Baroda

311, Pujer Complex, Subhanpura, Baroda - 390 023
Tel: 0265-2395 830/35/36/41/45

Indore

United Compound, A.B. Road, Dewas Naka,
Indore (MP) - 452 010.
Tel: 92851 11002

Bhubaneshwar

Hindustan Associates, Plot no. 135,
Mancheshwar Industrial Estate, Rasulgarh,
Bhubaneshwar - 751 010
Tel: 0674-6450 804

Nagpur

Flat No. 8, Plot No. 191, 1st Floor, Rachna Apartment,
Cement Road, Shivaji Nagar, Nagpur - 440 010
Tel: 0712-2569 878

Cochin

VI/409-D, Valomkottil Building,
Opp. BMC, Sea Port-Air Port Road, P.O. Thrikkakkara,
Cochin - 682 021
Tel: 98957 08464

Wipro Lighting Advantage

Innovative lighting solutions for indoor and outdoor applications through:

- Energy saving solutions with latest international technologies
- Capability to service multi-locational accounts
- Service commitment: 19 branches and over 350 dedicated stockists
- Ease of contact through website
- Trustworthiness and Reliability of Wipro

www.wiprolighting.com

Toll-free no: 1800-425-1969

Follow us on    



Scan the QR code
to download the app

www.wiprolighting.com

Toll-free no: 1800-425-1969

Follow us on

